

DOLL SHITING TECHNOLOGY

LAPPING & POLISHING



CONTACTS



POLISHING TECHNOLOGY®

Located in Gaillard, LAM PLAN specializes in industrial lapping and polishing solutions.

For 60 years, LAM PLAN teams have been designing and providing equipment and preparations guaranteeing its customers performance, quality and productivity.



SDS

Safety data sheets

Download all the safety data sheets in PDF format LAM PLAN according to the REACH and CLP regulations: (Classification Labelling Packaging).



www.fdsen.lamplan.com

CATALOGS

The 4 catalogues in English

Download in PDF format LAM PLAN the LAM PLAN catalogs and find all the polishing technologies.



www.caten.lamplan.com

MANUALS

Instructions for use

Download in PDF format the operating instructions and manuals of the different LAM PLAN machines and products.



www.manen.lamplan.com



LAM PLAN SA

7 rue des Jardins
BP 15
74240 Gaillard - France

Tel. +33 (0)4 50 43 96 30
Fax: +33 (0)4 50 87 01 60
email: mmsystem@lamplan.fr

www.lamplan.com



VIDEOS

Machine and product films

Watch the videos of our different machines by scanning the QRcode located on the «machine» pages of this catalog using your smartphone and find all of our videos.



www.viden.lamplan.com

Contact our technical team

email: biodiamant@lamplan.fr

For all questions

Tel. +33 (0)4 50 43 96 30

Social networks

Follow our news and events ...



Copyright © 2022 LAM PLAN. All Rights Reserved.

LAM PLAN, SERVICES



TESTING LABORATORY

Attentive to your need, we assist you regarding the process of defining and interpreting your expectations. The fine expertise of your demand combined to our best know-how enable us to shape a tailor made solution for you.



Take a virtual tour of our test centre on www.360en.lamplan.com



From the formal request to the detailed test report our CUSTOMER TEST CENTRE is at your disposal.



Always gather the best of your investments

By choosing LAM PLAN 's equipment, you will benefit the service and monitoring of our technicians. As a machinery and consumable manufacturer, we provide our entire experience and resources for your satisfaction.



Commissioning and Training

Our aim is for you to become immediately efficient and productive. We will train you in the use of the material and in the implementation of the included consumables.

Preventive Maintenance

LAM PLAN offers you punctual preventive maintenance tasks or annual contracts designed for each machine. We provide regular monitoring of your machines profiting an optimised management of maintenance costs, minimising the frequencies of failures.

The curative maintenance

In case of a failure which would cause the cessation of your production, the rapidity of reaction is preeminent. It mostly lays on the quality of the diagnosis and the availability of replacement parts. These curative maintenances are operated for all LAM PLAN's machinery.

The Retrofit

Retrofit maintenances include the upgrade of old equipment in order to prolong their use or to comply with new standards.

We also assure you the installation of optional equipment to improve your material and adjust it to your requirements.

FROM INNOVATION TO DESIGN AND MANUFACTURING

Your requirements are a constant source of innovation. The LAM PLAN technical team addresses all challenges and attempts to respond to specific issues in a simple way, that remains safe and comfortable to handle.

Our constant renewed ability to improve our machines, supports and products, combined with our original know-how, enable us to respond to all demands.

Lapping, polishing, metallography: mastering these 3 lines of business empowers us to respond the most varied customer demands. Our know-how is spread into each distinct sector, through an overview of the volume of solutions.



Supports

Plates, rods, abrasive discs, polishing pads, we develop a full range of supports making it possible to reach any surfaces and remove the required matter.



Abrasive solutions

Preparations in the form of pastes and liquids, conventional and diamond abrasives, we develop formulations that respect the health of users and preserve the environment without compromising efficiency.



Machines

Whether your needs go for lapping, polishing or metallography, our range of machines and peripheral devices offer you a complete equipment to treat all type of parts.

Quality assurance

The ISO 9001 certification constitutes the base of our approach to perpetual enhancement and concern about customer's needs, which enables us to respond to it properly. This certification of quality management within our organisation guarantees a permanent monitoring of our system's performance, quality of our products and services. Our goal: The customers' satisfaction.

COMPANY CERTIFIED
ISO 9001

PROMOTES THE CERTIFICATION
ISO 14000

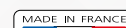

TABLE OF CONTENTS

EQUIPMENT

LAPPING & POLISHING MACHINES	Machine capacities		8
	M.M.8400	NEW	9
	M.M.8600		10
	M.M.9480 and M.M. 9380 S	NEW	11
	M.M.9700	NEW	12-13
	M.M.9100	NEW	14-15
	M.M.9120 and M.M.9150	NEW	15
	MASTERLAM® EVOLUTION		16
	M.M.2380		17
	ACCESSORIES	Dosing units dedicated to LAM PLAN machines: type 709, 710, 719	NEW
Autonomous dosing units: M.M.909, M.M.909 HV and M.M.809B			19
Adaptable automatic dosing units 910 and 910.2		NEW	20
Mixing and distribution systems: type 8017, 8003 and 8007		NEW	20-21
Table of characteristics, recommendations and compatibility of dosing units			21-22
Consumables for dosing units			23
Cast iron conditioning rings			24
Ceramic conditioning rings with SPYLAP®			24
Plastic rings			24
Protection discs series 881 and 883			25
Holder discs series 885			25
FAS® system			26
FIXING® discs			26
Carriers for single and double-side machines			27
FIXPAD® system			28
Micrometric gauges, monochromatic lamp and optical gauges			29
Diabloc system: black, purple, blue and green			30
Refills for Diabloc system: black, purple, blue and green			31
AUTOPLAN system			32
Washing tanks		33	
Protective film		33	
Cleaning products: STANOL barrel and detergent 742 and 743		33	

SUPPORTS

LAPPING SUPPORTS	Cast iron plates		34
	NEW LAM® M'M' plates		35-36
	EVOLAM composite plates	NEW	37
	Series 2000 mono-component plates		38
	Manual lapping plates : LAMBLOCK and TRI-BLOCS NEW LAM® M'M'	NEW	39
	Temperature control system P803 regulator		40
	Lapping rods M.M.®		41-44
Expandable cylindric rods		45-46	
POLISHING SUPPORTS	Alumina abrasive films		47
	Diamond HC abrasive films and abrasive films in rolls		48
	DIALAM diamond discs		49
	BOOSTER Lubricant		49
	ABRABLOC dressing rings		49
	TOUHLAM® polishing cloths	NEW	50-54
Structured cloths		55	

CONSUMABLES

DIAMOND SLURRIES	Bio DIAMANT® NEOLAP®	56-58
	Diamond slurries 241 series	59
	ECO® abrasive slurries	60
	Bio DIAMANT® sticks : M.M.140 A, M.M. 130, M.M. 140, serie 122	61-62
	Bio DIAMANT® pastes: serie 210	63
	Diadoseurs Bio DIAMANT® gels series 400	63
LUBRICATING FLUIDS	NEOFLUID, M.M.712, 705, M.M.990-140, 950-140	64
	Manual distributor	64
COMPOSITE ABRASIVES	CLASSICAL composite abrasive	65
	BIOLAM® composite abrasive	66-67
	AQUA LAM® colloidal silica: S.W. 30-36, NOVAL S finishing and NOVAL concentrated	68
	Abrasive compounds BIOLAP®: L and Cr L series	69-70
	Abrasive compounds CLASSIC	71
	AQUA LAM® powders: Al ₂ O ₃ , SiC, CeO ₂	72-73
	Additif 716	73
ADDITIFS, LUBRIFICANTS, OILS	Lapping oil 708 and lubricant for cylindrical lapping AQUASUN	74
	Granulometry: correspondences between different standards	74
	General terms and conditions of sale	76-77

55 YEARS OF PASSION

FOR INNOVATION
DEDICATED TO OUR CUSTOMERS

LAM PLAN S.A. was awarded the TALENT INPI trophy by the National Institute of Industrial Property.

This distinction is awarded to SME-SMI companies that innovate and include industrial property in their development strategy and growth plans.



MASTERING LAPPING & POLISHING IN PRODUCTION AND MAINTENANCE

SINGLE AND DOUBLE PLATE LAPPING POLISHING

The guarantee of repeatable lapping and polishing operations requires the use of modular or customized machines. The equipment, accessories and options can be selected upstream by the customer's R&D team or be subject to adjustments or recommendations by the LAM PLAN team.



Integrated modem for remote maintenance

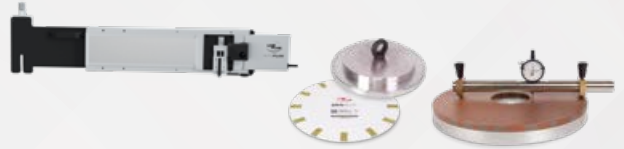

Maintaining the plate's geometry and surfacing: //Autoplan //Diabloc //Flatness gauge



Wireless stock removal measuring system

Production data acquisition and integration into the **INDUSTRY 4.0** environment



Special machines custom development multi-step set



Temperature control system



Customized Pads and FAS® coating

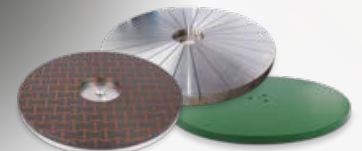

Plates: //Cast iron and composite //FAS and magnetic



Dosing and dispensing units: //Diamond //Conventional abrasive

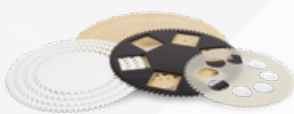

Carriers



Conditioning rings: //Cast iron //Ceramic //PVC

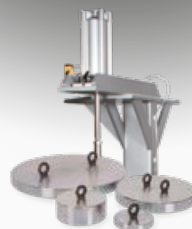

Pressure systems: //Weight //Pneumatic //Weight compensation

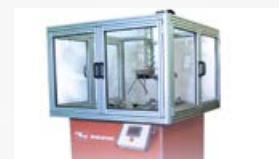

Safety devices

AN OFFER COVERING ALL MARKET NEEDS

LAPPING

The lapping process consists in obtaining a flatness and/or a specific roughness for the finishing of parts for production or maintenance work.

The surface finish obtained on a cast iron plate with conventional abrasives is in the range of $0.4 \mu\text{m Ra}$ with a matt aspect.

With a composite plate and a diamond abrasive, a Ra of $0.07 \mu\text{m}$ and a shiny aspect can be achieved.

Diamond plates
DIALAM®



Cast iron plates



Patented New Lam M'M®
and EVOLAM® composites
plates



Expandable rods



New Lam M'M®
composite rods



NEOLAP® diamond
liquids and
BioDIAMANT® pastes



LAQUA LAM® abrasive
liquids and pastes
(SiC , Al_2O_3 , B_4C , CeO_2)



POLISHING SUPER FINISHING

The polishing and surface finishing operations need to meet technical, dimensional and aesthetic requirements. The surface finish obtained is characterized by a low roughness $0.01 \mu\text{m Ra}$, a brightness which is subjected to visual and/or microscopic control. Due to the diversity of the materials encountered, the surface finish of the raw parts and the result to be sought, the superfinishing requires extremely varied preparation techniques which make use of the full range of LAM PLAN know-how.

TOUCLAM®
polishing pads:
polyurethane, woven,
non-woven, flocked,
compressed

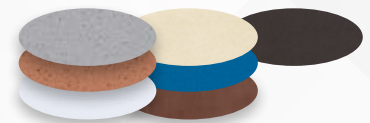

Diamond abrasive films
Alumine abrasive films



Abrasive preparations
ECO® , NEODIA® ,
NEOLAP® , BioDIAMANT®
M.M. Series



Colloidal silicas



Super finishing liquids
ALPLAN, L1, L2
and FINAL



EQUIPMENT

Machine capacities

LAM PLAN lapping and polishing machines have been developed and perfected with LAM PLAN M'M' patented technology. They respond to all market requirements which require the obtention of high quality polished surfaces or flatnesses under one micron.

The wide range of the machine versions in this catalogue, will enable you to treat pieces from micro-mechanic up to a seal part measuring several decimetres. Linked to our consumables range, you will be assured of repeatable results on all industrial materials.

SIMPLE FACE LAPPING MACHINE CAPACITIES

Number of parts per ring.

Part Ø (mm)	Number of parts							
	M.M.8400	M.M.9480 S	M.M.8600	M.M.9700 E/S/SHP	M.M.9100 E/S	M.M.9100 EC	M.M.9120 E/S	M.M.9150 E/S
Ø 5	170	230	320	362				
Ø 10	67	95	150	160	225	225		
Ø 20	20	30	53	67	105	105	175	263
Ø 30	8	19	25	32	63	63	97	145
Ø 40	6	11	18	23	42	42	60	90
Ø 50	4	6	10	16	26	26	33	54
Ø 70	1	3	6	7	16	16	24	29
Ø 100	1	1	3	4	7	7	14	18
Ø 130	1	1	1	2	5	5	7	10
Ø 160		1	1	1	3	3	5	7
Ø 210			1	1	1	1	3	4
Ø 290					1	1	1	2
Ø 350					1	1	1	1
Ø 450							1	1
Ø 480								1
Ø 580								1

DOUBLE-SIDE LAPPING MACHINE CAPACITIES

Number of parts per satellite.

Part Ø (mm)	Number of parts	
	M.M.2380	Masterlam EVOLUTION
Ø 5	180	46
Ø 10	70	18
Ø 15	30	8
Ø 20	20	4

LAM PLAN lapping and polishing machines have been developed and perfected with LAM PLAN M'M' patented technology. They respond to all market requirements which require the obtention of high quality polished surfaces or flatnesses under one micron.

The wide range of the versions of machines in this catalogue, will enable you to treat pieces from micro-mechanic up to a seal part measuring several decimetres.

LAPPING & POLISHING MACHINES

M.M.8400**NEW**

The M.M.8400 and M.M.8600 machines are both lapping and polishing equipment which enable you to integrate a means of flat surface finishing into your workshop, at a reasonable price.

Their compact size and ergonomic controls facilitate their installation and use. The simple tried and tested design, equipped with medium dimension plates, enables you to cost effectively produce small runs.

Equipped with either a cast iron plate, DIALAM®, LAM PLAN M'M' or FAS®, this range of machines lets you achieve any type of surface finish defined by your specification (e.g. lapping, stock removal, grinding, polishing etc.)

Lapping machines M.M.8400 and M.M.8600 are also perfectly suited to your maintenance operations on all seal parts (e.g. safety valves or small mechanical parts lapping).

The process is controlled via a touchscreen, which ensures good ergonomic and intuitive use. This range of machines also gives you the possibility of saving programmes, assuring repeatability of lapping/polishing processes implemented in your workshops.

This range of machines is compatible with the new LAM PLAN 709, 710, and 719 distribution systems managed directly from the machine's control panel.

**M.M. 8400**

Variable production of small parts:
Ø 5 to 130 mm



M.M.8400 equipped with the dosing unit M.M.709

Options

Support cabinet height 73 cm, 1 door and 2 compartments	10 M8400 00
MESUREO Stock removal measurement	10 84003 00

Technical data	M.M.8400
Plate Ø	381 mm
Inner ring Ø	138 mm
Capacity per ring	1 part Ø130 mm or 170 parts Ø 5 mm
Number of rings	3
Electric power supply	230 V single-phase
Motor Power	0.37 kW
Control	Touch screen 3,5 inches
Plate rotation speed	From 30 to 90 rpm
Dimensions (W x D x H)	625 x 725 x 450 mm
Weight (without plate)	70 kg
Abrasive distribution system	Included - Type depending on the plate
Reference	10 08400 00



Support cabinet

Available equipment

These machines can be equipped with all LAM PLAN plates.

The various accessories offered (distribution unit, FAS® plates, polishing cloths, etc) enable adaption of the basic machine for any specific operations (micro-mechanic, watchmaking, electronic, etc).



MESUREO

Measurement of removal of material: ref. 10 84003 00

A system enabling obtention of flat surfaces at less than one micron, combined with a parallelism of quality between the lapped face and a reference.

The MESUREO is comprised of a perfectly flat pressure disc, which is able to transpose on a vertical axis, therefore producing pressure on the opposite face of the surface to be lapped.

The pressure plate is guided by a high precision ball bearing socket. Also, at the end of the polishing cycle, the parts contained by this tool will have a parallelism inferior to 5 microns.

The pressure surface is ceramic, assuring a long life, with no risk of metallic contamination.

Finally, this tool is equipped with a wireless sensor, allowing visualisation of material removal in real time on a PC placed next to the lapping machine to which this device is connected. The target dimension can be programmed. Therefore, the operator, via an intuitive colour range on the monitor, can instantly visualise whether or not the parts are within the defined thickness tolerance.

Example of applications for M.M.8400: lapping of impressions for stamping



Mixing plate



Watch parts polishing, mounted on a bracket



Lapping of impressions for stamping

M.M.8600

The M.M.8600 is a very competitive machine which is suitable for maintenance procedures or for one-off or reduced production runs.

Its Ø 600mm plate enables you to obtain any level in terms of geometry or surfacing.

The M.M.8600 is compatible with all lapping and polishing supports as well as all LAM PLAN distributions systems.



M.M. 8600

Moderate production of parts:
Ø 5 to 210 mm

Technical data	M.M.8600
Plate Ø	610 mm
Inner ring Ø	248 mm
Capacity per ring	1 part Ø210 mm or 320 parts Ø 5 mm
Number of rings	3
Electric power supply	230 V single-phase
Motor Power	2.2 kW
Control	Touch screen 3,5 inches
Plate rotation speed	From 30 to 90 rpm
Dimensions (W x D x H)	1150 x 1150 x 1000 mm
Weight (without plate)	400 kg
Abrasive distribution system	Included - Type depending on the plate
Reference	10 08601 00

LAPPING & POLISHING MACHINES

M.M.9480

NEW

M.M.9480 S VERSION

The M.M.9480 S is the new 9000 series small diameter flat lapping machine.

This Ø 480 mm lapping machine has all the technical solutions of the large capacity models. Therefore, it is particularly robust and stable.

The support plate rests on a trust ball bearing, providing strong stability. The gear motor is protected even in high pressure conditions.

Fully equipped in its standard version, it has an electronically controlled 3 cylinder arm.

The machine's smaller size makes it easier for the operator to manipulate all the accessories, such as changing the plate or loading and unloading the rings.

All basic functions of this lapping machine built for production are integrated in the 5.7" touchscreen in an intuitive interface based on icons. This allows you to control all distributing units of the LAM PLAN range and to save 12 programmes. A modem is integrated in the machine in order to carry out remote maintenance.



Technical data	M.M.9480 S version
Plate Ø	480 mm
Inner ring Ø	182 mm
Capacity per ring	1 part Ø 160 mm or 95 parts Ø 10 mm
Number of rings	3
Electric power supply	230 V monophasé
Motor Power	1.5 kW
Pressure application system	3 pneumatic cylinders
Pressure	10 to 600 N
Control	Touch screen 5,7 inches
Plate rotation speed	From 15 to 90 tr/min
Dimensions (W x H x D)	1160 x 860 x 1620 mm
Weight (without plate)	300 kg
Abrasive distribution system	Included - See specific table
Reference	10 94805 00

Options for M.M.9480 S

Flatness gauge for checking the flatness of the lapping plate	08 00899 00
Level sensors for diamond liquid and lubricating fluid	08 90001 00

**M.M. 9480**

Intensive production of parts :
Ø 5 to 160 mm



Particularly suitable for maintenance workshops, production of small parts and finishing process on high end watchmaking parts.

It is a compact piece of equipment of the highest quality, which responds to the highest finishing requirements as well as intensive production.

The M.M.9480 S is also compatible with the AUTOPLAN system for plate flatness reconditioning.

AUTOPLAN system: flatness reconditioning and grooving of the plate.

The AUTOPLAN system enables effective management of plate flatness and grooving. It is positioned and dismantled in a few minutes thanks to the dedicated fixation points integrated in the machine.

VERSION M.M.9380 S

Also available with a Ø 380 mm plate - M.M.9380 S

10 93805 00



M.M.9700

NEW

In order to respond to the most demanding specifications in terms of surface flatness and process repeatability, LAM PLAN has developed a new series of M.M.9000 machines, of which the M.M.9700 is the mid-range machine.

Fitted with a \varnothing 700 mm lapping plate, this machine has a new, highly intuitive touchscreen, enabling the user to quickly grasp the operation of the machine.

From a mechanical viewpoint, a large dimension thrust ball bearing is inserted under the machine's basic plate. This mechanism guarantees plate stability, even under a heavy load. This new concept also enables reduced demand on the gear motor group, assuring greater longevity of the equipment. Machine safety has also been improved with anti-pinch devices connected to the retaining arm castors of the conditioning rings.

Finally, the machine's new electrical design, allows easy development of machine functions and in response to your future needs, with, for example, later integration of the AUTOPLAN system, or different types of LAM PLAN distribution systems.

Therefore, this machine is intended for use in all high production workshops.



M.M. 9700

Intensive production for parts:
 \varnothing 5 to 210 mm

AUTOPLAN system: flatness reconditioning and grooving of the plate.



AUTOPLAN system enables to manage efficiently the flatness and the grooving of the plate. It is installable and removable in a few minutes thanks to fixation points integrated to the machine.



Technical data	M.M.9700 E version
Plate \varnothing	700 mm
Inner ring \varnothing	274 mm
Capacity per ring	1 part \varnothing 210 mm or 160 parts \varnothing 10 mm
Number of rings	3
Electric power supply	400 V - 50 Hz - 3 phases + earth + neutral
Motor Power	2.2 kW
Pressure application system	3 weights of 13 kg included
Control	Touch screen 5,7 inches
Plate rotation speed	From 30 to 90 rpm
Dimensions (W x H x D)	1500 x 1300 x 1450 mm
Weight (without plate)	800 kg
Abrasive distribution system	Included - See specific table
Reference	10 9700E 00

Options for M.M.9700 E

Level sensors for diamond liquid and lubricating fluid	08 90001 00
Flatness gauge for checking the flatness of the lapping plate	08 00894 00

LAPPING & POLISHING MACHINES

M.M.9700 S VERSION**NEW**

The M.M.9700 S version of the machine integrates a pneumatic pressure system which is controlled from the general interface.

Comprising three double effect cylinders and three ball mounted aluminium discs, this device negates handling weights. Loading and unloading times are optimised and handling effort is reduced.

Pressure can be adjusted between 0 and 700 N.



What changes	M.M.9700 S version
Pressure application system	3 double effect cylinders
Pressure	45 to 1000 N
Dimensions (W x H x D)	1500 x 1500 x 1900 mm
Weight (without plate)	1 000 kg
Reference	10 9700S 00

Options for M.M.9700 S

Level sensors for diamond liquid and lubricating fluid	08 90001 00
Refrigeration and heating unit P803, for lapping plate	10 80003 90
Flatness gauge for checking the flatness of the lapping plate	08 00894 00

EQUIPMENT

All M.M.9000 series machines are fitted with an integrated modem as standard in order to carry out remote maintenance operations.

They are compatible with dedicated LAM PLAN distribution systems and can be optionally fitted with an abrasive and lubricant level sensor.

Production data collection in the form of CSV files is possible via the USB interface.

M.M.9700 S HP VERSION (HIGH POWER)**NEW**

A machine specially developed to answer polishing needs in production of parts requiring high pressure, associated with high speed plate rotation and use of specific abrasives.

The pressure system and motorisation have been adapted to the specific requirements of heavy loads and high torque.

The use of stainless steel in the machine's production, is generalised to resist certain relatively aggressive abrasive types. The machine is equipped with protective casing around the work zone, to avoid high speed projection of abrasives. It is removable and motorised.

The M.M.9700 S HP can be fitted with distribution systems suited to the required abrasives, for example high flow peristaltic pumps.



What changes	M.M.9700 S HP version (high power)
Motor Power	7,5 kW
Pressure application system	3 double effect cylinders
Pressure	100 to 2500 N
Plate rotation speed	From 15 to 125 tr/mn
Dimensions (W x H x D)	1540 x 1200 x 1800 mm
Weight (without plate)	980 kg
Reference	10 9700SP 00

Options M.M.9700 S HP version

Refrigeration and heating unit P803, for lapping plate	10 80003 90
Flatness gauge for checking the flatness of the lapping plate	08 00894 00





M.M.9100

NEW

Lapping techniques with heavy loads and intensive use require a suitably durable material. This is offered by the LAM PLAN mid and large diameter range of machines.

The rigidity of their structures and the gear motor group torque are especially suited to the high abrasion of LAM PLAN lapping plates.

The number of peripheral devices available make the machines particularly versatile and effective. Specific equipment can be made available according to requirements.



M.M. 9100

Intensive production for parts:
Ø 10 à 350 mm

AUTOPLAN system: flatness reconditioning and grooving of the plate.



AUTOPLAN system enables to manage efficiently the flatness and the grooving of the plate. It is installable and removable in a few minutes thanks to fixation points integrated to the machine.

M.M.9100 S VERSION

NEW

Version with pneumatic pressure comprising three double effect cylinders mounted on a fixed arm.



Technical data	M.M.9100 E version
Plate Ø	1 000 mm
Inner ring Ø	406 mm
Capacity per ring	1 part Ø 350 mm or 225 pièces Ø 10 mm
Number of rings	3
Electric power supply	400 V - 50 Hz - 3 phases + earth + neutral
Motor Power	5,5 kW
Pressure application system	3 weights of 28 kg included
Control	Touch screen 5,7 inches
Plate rotation speed	From 15 to 50 tr/min
Dimensions (W x H x D)	1900 x 1800 x 1500 mm
Weight (without plate)	1 000 kg
Abrasive distribution system	Included - see specific table
Reference	109100E 00

What changes	M.M.9100 S version
Pressure application system	3 double effect cylinders
Pressure	10 to 2500 N
Dimensions (W x H x D)	1900 x 1800 x 2300 mm
Weight (without plate)	1 400 kg
Reference	109100S 00

Options for M.M.9100 S

Level sensors for diamond liquid and lubricating fluid	08 90001 00
Refrigeration and heating unit P803, for lapping plate	10 80003 90
Flatness gauge for checking the flatness of the lapping plate	08 00893 00

LAPPING & POLISHING MACHINES

M.M.9100 SR VERSION**NEW**

The S, S HP and EC type lapping machines are equipped with pneumatic pressure systems of different powers. The cylinders are installed on fixed or mobile arms. On the SR version the arm turns around its 180° axis thanks to a motorised crown and is controlled by the man/machine interface. This facilitates access to the work zone, plate changing and allows passage of a robotised loading/unloading arm.

**What changes** **M.M.9100 SR version**

Pressure application system	3 pneumatic cylinders, rotating arm motorized
Dimensions (W x H x D)	1900 x 1900 x 2300 mm
Weight (without plate)	1 500 kg
Reference	10 9100SR 00

Options for M.M.9100 SR and EC

Level sensors for diamond liquid and lubricating fluid	08 90001 00
Refrigeration and heating unit P803, for lapping plate	10 80003 90
Flatness gauge for checking the flatness of the lapping plate	08 00893 00

M.M.9120 et M.M.9150

Based on the M.M.9000 series technology, we offer versions of our machines with plates between Ø 1200 mm and 1500 mm for maintenance operations on large parts or for production applications. A technical study and specifications will be provided on demand.

Available versions:

M.M.9120 E	Ø 1200 mm, without pressure system
M.M.9120 S	Ø 1200 mm, 3 pneumatic pressure cylinders
M.M.9120 SR	Ø 1200 mm, 3 pneumatic pressure cylinders on a motorized rotating arm
M.M.9120 S4R	Ø 1200 mm, 4 rings et 4 pneumatic pressure cylinders on a motorized rotating arm
M.M.9150 E	Ø 1500 mm, without pressure system
M.M.9150 S	Ø 1500 mm, 3 pneumatic pressure cylinders

M.M.9100 EC VERSION**NEW**

If the part which has to be worked is too heavy regarding the pressure prescription required for a lapping operation, lapping machine EC will have to be used. This machine's version is equipped with a pneumatic bracket which will unballast the lapping plate of the workpart weight, and provide an optimal pressure for the lapping process.

**What changes** **M.M.9100 EC version**

Load compensation system	1 pneumatic cylinder, rotating arm motorized
Compensation applicable	10 to 2500 N
Dimensions (W x H x D)	1900 x 1900 x 2300 mm
Weight (without plate)	1450 kg
Reference	10 9100EC 00

EQUIPMENT

All M.M.9000 series machines are fitted with an integrated modem as standard in order to carry out remote maintenance operations.

They are compatible with dedicated LAM PLAN distribution systems and can be optionally fitted with an abrasive and lubricant level sensor.

Production data collection in the form of CSV files is possible via the USB interface.

Referent in the domain of production lapping/polishing and material finishing, LAM PLAN has also been manufacturing and selling consumables dedicated to double-side polishing applications with the range of ECOA® liquids and TOUCHLAM® supports. In continuity of our approach in proposing complete process: products/machines/methods to our customers, we have developed a double-side range of machines to make you benefit from LAM PLAN's experience obtained over the past 60 years.



MASTERLAM®

Small series & double-side prototyping
for parts: Ø 5 to 20 mm

A security housing is proposed in option. This entirely transparent cover assures a protection of the moving parts without distorting the surveillance of the operator during the cycle. Once open, the work space becomes perfectly accessible.



The MASTERLAM® Evolution can be equipped with the MASTERLAM® series secured transparent housing.

Lifting and lowering of the superior plate with pneumatic cylinder



MASTERLAM® Evolution

In order to answer to double-side polishing issues in small series or development phase, LAM PLAN proposes the MASTERLAM® Evolution, an original and innovating approach for double-side polishing.

The MASTERLAM® Evolution is a compact and economical solution for double-side polishing, to realise high quality polishing on any kind of small parts. This equipment is particularly well-adjusted for the finishing of watch components in small series, pre-series or prototyping.

Description

The MASTERLAM® Evolution is based on a simple kinematic proposing 2 movements: clock-wise or anti-clockwise rotation of the superior plate and the main cogwheel with speed programming. These 2 movements will allow you to respond to most of your needs in terms of polishing of small series of all types of materials.

Touch screen control panel

The 5.7 inches' touch screen in this machine will enable you to manage all the settings: cycle time, rotational speed, rotation movement, pressure during cycle and abrasives distribution sequences. This intuitive screen is also offering you the possibility to save more than 300 operating ranges. A water rinse phase is also possible at the end of the cycle.

A well-equipped and safe machine

The MASTERLAM® Evolution outer ring gear is made of 316 L stainless steel, assuring a durability of the moving parts. The machine is also equipped with two FAS® plates facilitating the setting up of the polishing cloths.

Technical data	MASTERLAM® Evolution
Plate Capacity	7 carriers track Ø 250 mm ext. Ø 130 mm int.
Useful capacity	7 satellites Ø 65 mm
Superior plate rotational speed	20 to 150 rpm; Bidirectional rotation
Cogwheel rotational speed	20 to 150 rpm; Bidirectional rotation
Cogwheel motor power	0.75 kW
Superior plate motor power	0.2 kW
Pressure	5 to 400 N
Required energies	230 V-50 Hz single-phase Compressed air 6 bars filtered 10 µm
Dimensions (WxHxD)	550 x 670 x 670 mm
Total power	2.5 kW
Noise level	< 80 db at 1 metre away
Weight	95 kg
Reference	60ML1EVO00

LAPPING & POLISHING MACHINES

M.M.2380

Developed on well-known and proven technological bases, this equipment will perfectly respond to your needs in terms of double-side lapping and polishing of parts with a diameter between 5 and 30 mm.

Capable of integrating LAM PLAN lapping plates, this machine will be the solution when obtaining a geometry and ratings dimensions are key factors. In parallel, the possibility of associating the M.M.2380 to polishing supports will enable you to answer your needs when the quality of the polished surface is the decisive criteria.

Description

The M.M.2380 is built on a welded and bolted steel frame to guarantee stable and repeatable results. The plates (inferior and superior) and the central cog drive is assured by "brushless" motors, allowing to regulate the speed and to choose the rotational direction. The plates have a 380 mm exterior diameter and allow the use of 5 carriers with a usefull capacity of \varnothing 125 mm.

Touch screen control panel

All the machine settings are controlled through a large 10.5 inches touch screen. The design of the Man-machine interface assures an efficient equipment handling. This screen will show the pressure applied on the parts and the motor torque in real time. The M.M.2380 can also be endowed with a "stock removal measurement" system. Apart from the cycle time, the machine automatically stops its cycle when the target thickness of the parts is reached.

User-friendly device

The M.M.2380 can be equipped with a system enabling a rapid setting of the carriers. A "rack" system enables to store many satellites filled by the operator in masked time. The ring gear has a removable part to facilitate loading and unloading the carriers. The operator can proceed to a transfer of carriers by sliding them on a thin magnetic slab.

This device can be fitted with a ring gear or a pin ring permitting the use of carriers you would already have for similar applications.

Finally, a series of associated accessories has been developed by LAM PLAN for this machine. The FIXPAD® system associated with the FAS® will facilitate the shift of polishing pads. Moreover, LAM PLAN proposes its range of TOUCHLAM® discs, specially adapted to the superior and inferior plates of the machine.



M.M. 2380

Double-side production for parts:
 \varnothing 5 to 30 mm



Technical data	M.M.2380
Plate Capacity	5 carriers track \varnothing 380 mm ext. / \varnothing 153 mm int.
Useful capacity	5 carriers \varnothing 125 mm
Superior plate rotational speed	0 to 160 rpm; Bidirectional rotation
Gearwheel rotational speed	0 to 80 rpm; Bidirectional rotation
Motors power (plates and gearwheel)	0.75 kW for each motor
Required energies	400 V-50 Hz three-phase + neutral. Compressed air 6 bars filtered 10 μ m
Dimensions W x H x D	960 x 2030 x 780 mm Working table height 1040 mm
Total power	2.5 kW
Noise level	<80 dB at 1 meter away
Weight	650 kg
Reference	10 23800 00

Automatic distribution system

The automatic distribution system ensures precise and regular distribution of products. It's the solution for abrasive film control and lubrication. The yield of removed material and temperature control depend directly on the quality and constancy of the abrasive film.

The various adjustments, distribution intervals, spraying times, head positioning, enable homogeneous and reproducible polishing results, as well as economising on consumables.

The 719 and MM 809B distribution systems are venturi type systems which allow product to be sprayed when the 709, 710 and MM909 systems are equipped with peristaltic pumps which deliver products drop by drop or flowing.

The venturi system is reserved for low viscosity and high decanting products, for instance, certain oil-based products. The peristaltic system is more versatile and has the advantage of not generating mist.

The high volume 8000 series distribution systems are those based on vortex pump systems for the 8003 and 8007 models and peristaltic high flow for the 8017 model, suitable for high volume products generally used in production applications. They are primarily reserved for SiC abrasives which have a high tendency to settle.



Dosing unit dedicated to LAM PLAN machines

DOSING UNIT TYPE 709

NEW

Peristaltic model for WATER-BASED abrasives.

Reference	08 01709 00
Capacity	2 x 500 cc including 1 with agitator
Electric power supply	220V single phase + 24 V input for control
Pump flow rate	0,5 ml/sec.
Distribution system	Nozzles not included, see machine recommendation.



DOSING UNIT TYPE 710

NEW

Peristaltic model for OIL-BASED abrasives.

Reference	08 01710 00
Capacity	2 x 500 cc including 1 with agitator
Electric power supply	220V single phase + 24 V input for control
Pump flow rate	0,5 ml/sec.
Distribution system	Nozzles not included, see machine recommendation.



DOSING UNIT TYPE 719

NEW

Venturi model for OIL-BASED abrasives with settling tendency.

Reference	08 01719 00
Capacity	2 x 500 cc including 1 with agitator
Electric power supply	220V single phase + 24 V input for control
Pump flow rate	N.C.
Distribution system	Nozzles not included, see machine recommendation.

OPTIONAL LEVEL SENSORS

Set of 2 level sensors for diamond liquid and lubricant.

Reference	08 90001 00
-----------	-------------

ACCESSORIES

Autonomous dosing unit

The 909 and 809 independent distribution systems enable you to easily equip any type of machine with an efficient distribution system. It's the ideal solution to retrofit or improve your equipment.

DOSING UNIT M.M.909 - PERISTALTIC

Distribution system	3 standard peristaltic pumps With an outlet to drive an external pump
Control	Touch screen
Electrical power supply	220 V single-phase - 50 Hz
Dosing machine communication	1 x 24 V input for machine servoing

Designation	Qty.	Ref.
DOSING UNIT M.M.909 ADAPTABLE VERSION With a manual start/stop button	1 with 3 glass bottles 500 cc	08 03799 00
Stirrer	1 for glass bottle 500 cc	08 02816 00



Touch screen interface

DOSING UNIT M.M.909 HV - PERISTALTIC

Distribution system	2 standard peristaltic pumps, 1 large flow pump for high viscosity liquids and an outlet to drive an external pump
Control	Touch screen
Electrical power supply	220 V single-phase - 50 Hz
Dosing machine communication	1 x 24 V input for machine servoing

Designation	Qty.	Ref.
DOSING UNIT M.M.909 HV	1 with 3 glass bottles 500 cc	08 00799200
Stirrer	1 for glass bottle 500 cc	08 02816 00

DOSING UNIT M.M.809B - VENTURI

Distribution system	- Distribution of 2 different liquids by Venturi system - 1 liquid compartment with an agitator
Control	By analog buttons and timers
Compressed air feed system	2 bars
Electrical power supply	220 V single-phase - 50 Hz
Dosing machine communication	1 x 220 V input for machine servoing

Designation	Qty.	Ref.
Dosing unit M.M.809B	1 with 2 glass bottles 500 cc	08 01809 10



M.M.809B dosing unit

Adaptable automated dosing

With the DOSER 910 and 910.2 you can equip all types of machines with a programmable and autonomous dosing system compatible with oil-based products and all types of lubricating fluids.



DOSING UNIT TYPE 910

NEW

Capacity	2 x 500 cc, 1 with agitator 2 peristaltic pumps
Electric power supply	220V single-phase
Distribution system	Nozzles not included

Designation	Qty.	Ref.
For machines from Ø 380 to 700 mm	1	08 00799 30

DOSING UNIT TYPE 910.2

NEW

Capacity	4 x 500 cc bottles with 2 stirrers 4 peristaltic pumps
Electric power supply	220V single-phase
Distribution system	Nozzles not included

Designation	Qty.	Ref.
For machines from Ø 380 to 700 mm	1	08 00799 40

Mixing and distribution systems

These distribution systems are suitable for any type of abrasive immersed in liquid whatever its composition. They enable the resolution of settling problems and guarantee regular and repetitive results.

Contact us if you would like to connect our mixing distributor to your lapping machine.



DOSING PUMP TYPE 8017

Controlled by the machine interface or by integrated sequencer for the autonomous version.

Pump type	1 peristaltic pump + mixing system
Bowl	Useful volume 7 litres
Electrical power supply	220V single-phase
Pump flow rate	3,5 ml/second
Dimensions	H 430 mm X Ø ground 250 mm
Distribution system	Nozzle 813 on mobile stand sold separately

Designation	Qty.	Capacity	Ref.
Dosing pump type 8017 for LAM PLAN machine	1	7 litres	08 08017 00
Independent dosing pump type 8017	1	7 litres	08 18017 00

ACCESSORIES

DOSING PUMP TYPE 8003

Controlled by the machine interface or by integrated sequencer for the autonomous version.

Pump type	1 vortex pump + mixing system
Bowl	Useful volume of 50 litres, on casters, drain valve
Electrical power supply	220V single-phase
Pump flow rate	50 litres/minute
Dimensions	H 870 mm X Ø ground 600 mm
Distribution system	3 swivelling outputs. Solenoid valve 3 tracks

Designation	Qty.	Capacity	Ref.
Dosing pump type 8003 for LAM PLAN machine	1	50 litres	W000 08003
Independent dosing pump type 8003	1	50 litres	W001 08003
Optional low abrasive warning system for 9000 series machines	1	-	08 90002 00

DOSING PUMP TYPE 8007

Controlled by the machine interface or by integrated sequencer for the autonomous version.

Pump type	1 vortex pump
Bowl	Useful volume 7 litres
Electrical power supply	220V single-phase
Pump flow rate	25 litres/minute
Dimensions	H 420 mm X Ø ground 250 mm
Distribution system	3 swivelling outputs. Solenoid valve 3 tracks

Designation	Qty.	Capacity	Ref.
Dosing pump type 8007 for LAM PLAN machine	1	7 litres	W000 08007
Independent dosing pump type 8007	1	7 litres	W001 08007

**RANGE OF LAM PLAN DOSING UNITS**

DOSING UNIT Designation	Pump type	Distribution system	Number of pumps	Capacities	Continuous flow per pump	Compatible products	Agitating	Dedicated LAM PLAN Version	Autonomous version
709	Peristaltic	Drip	2	2 x 500 cc	0,5 ml/sec.	Water base	Yes / 1 bottle	080170900	n.c.**
710	Peristaltic	Drip	2	2 x 500 cc	0,5 ml/sec.	Oil base	Yes / 1 bottle	080171000	n.c.
719	Venturi	Spray	2	2 x 500 cc	n.c.	Oil base + decantation	Yes / 1 bottle	080171900	n.c.
M.M.909	Peristaltic	Drip	3	3 x 500 cc	0,5 ml/sec.	Water base	Option	n.c.	08 03799 00
M.M.909 HV	Peristaltic	Drip	2 standards 1 large flow	3 x 500 cc	0,5 ml/sec. 3,5 ml/sec.	Water base + high viscosity	Option	n.c.	08 00799200
M.M.809 B	Venturi	Spray	2	2 x 500 cc	n.c.	All	Yes / 1 bottle	n.c.	08 01809 10
8017	Peristaltic	By casting	1	7 L	3,5 ml/sec.	All	Yes / pale	080801700	08 18017 00
8003	Vortex	By casting	1	50 L	50 L/min.	All	Yes / pale	W00008003	W001 08003
8007	Vortex	By casting	1	7 L	25 L/min.	All	No	W00008007	W001 08007
M.M.910	Peristaltic	Drip	2	2 x 500 cc	0,5 ml/sec.	Oil base	Yes / 1 bottle	n.c.	08 00799 30
M.M.910.2	Peristaltic	Drip	4	4 x 500 cc	0,5 ml/sec.	Oil base	Yes / 2 bottles	n.c.	08 00799 40

*depends on the viscosity of the liquid used

**non compatible

DOSING UNITS, RECOMMENDATIONS

PRODUCTS	LAPPING MACHINES	DOSING UNIT for LAM PLAN machines	DOSING UNIT for other machines	Pump type	NOZZLES	Ref NOZZLES
WATER BASE	Ø 381 to 700 mm	709		Peristaltic	Nozzle 813 on movable foot	08 00813 00
			M.M.909	Peristaltic	Nozzle 811 on movable foot	08 00811 00
	Ø 910 to 1000 mm	719	M.M.809B	Venturi	Nozzle 815 on movable foot	08 00815 20
		2 x 709	M.M.909	Peristaltic	2 x nozzle 811 L on movable foot	08 00811 10
		2 x 719	M.M.809B	Venturi	2 x nozzle 815 L on movable foot	08 00815 40
		2 x 709	M.M.909	Peristaltic	2 x nozzle 811 L on movable foot	08 00811 10
Ø 1200 to 1500 mm	2 x 719	2 x M.M.809B	Venturi	2 x nozzle 815 XL on movable foot	08 00815 60	
	2 x 710	M.M.910	Peristaltic	Nozzle 813 H on movable foot	08 00813 20	
OIL BASE AND EMULSION	Ø 381 to 700 mm	719	M.M.809B	Venturi	Nozzle 815 on movable foot	08 00815 20
		2 x 710	M.M.910.2	Peristaltic	2 x nozzle 811 HL on movable foot	08 00811 20
	Ø 910 to 1000 mm	2 x 719	2 x M.M.809B	Venturi	2 x nozzle 815 L on movable foot	08 00815 40
		2 x 710	M.M.910.2	Peristaltic	2 x nozzle 811 HL on movable foot	08 00811 20
		2 x 719	2 x M.M.809B	Venturi	2 x nozzle 815 XL on movable foot	08 00815 60
		2 x 710	M.M.910.2	Peristaltic	2 x nozzle 811 HL on movable foot	08 00811 20
AQUALAM COMPOSITE ABRASIVES	Ø 381 to 480 mm	M.M.8017	M.M.8017 autonomous	Peristaltic	Nozzle 813 on movable foot	08 00813 00
		M.M.8007	M.M.8007 autonomous	Vortex	Associated distribution system	System supplied with dosing unit
	Ø 600 to 1500 mm	M.M.8003	M.M.8003 autonomous	Vortex	Associated distribution system	System supplied with dosing unit
LAPPING OIL + POWDER	Ø 381 to 480 mm	M.M.8007	M.M.8007 autonomous	Vortex	Associated distribution system	System supplied with dosing unit
	Ø 600 to 1500 mm	M.M.8003	M.M.8003 autonomous	Vortex	Associated distribution system	System supplied with dosing unit



Nozzle 813 and 813H



Nozzle 811, 811 L and 811 HL



Nozzle 815, 815 L and 815 XL with anti-fog system

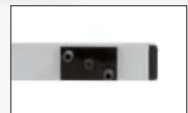

Distribution system for dosing unit type 8003 and 8007

ACCESSORIES

Consumables for dosing units

CONSUMABLES FOR M.M.709

Designation	Ref.
Versitec silicone hose Ø5-3 per metre - Water base	60 00271 90
Peristaltic pump body standard model	60 00667 90
Stirring paddle for dosing unit	08 00124 90

CONSUMABLES FOR M.M.710

Designation	Ref.
Hose D3.2 Yellow for - Oil base - Emulsion base	08 1050 10
Peristaltic Pump Oil Base	08 1050 07
Stirring paddle for dosing unit	08 00124 90

CONSUMABLES FOR M.M.719

Designation	Ref.
Flexible Crystal Hose Ø6 (venturi) per Meter - Oil and water base	60 00270 90
Stirring paddle for dosing unit	08 00124 90

CONSUMABLES FOR M.M.909

Designation	Ref.
Versitec silicone hose Ø5-3 per metre - Water base	60 00271 90
Peristaltic pump body standard model	60 00667 90
HV peristaltic pump body	60 00893 90
Versitec silicone hose Ø7-4 per metre	60 00272 90
Stirring paddle for dosing unit	08 00124 90

CONSUMABLES FOR M.M.809

Designation	Ref.
Tuyau Cristal Souple Ø6 (venturi) au Mètre - Base huile et eau	60 00270 90
Stirring paddle for dosing unit	08 00124 90

CONSUMABLES FOR M.M.8017

Designation	Ref.
HV peristaltic pump body - Water base	60 00893 90
Versitec silicone hose Ø7-4 per metre	60 00272 90

NOZZLES & GLASS BOTTLE

Designation	Qty.		Ref.
813	1		08 00813 00
813 L	1		08 00813 10
813 H	1	For peristaltic dosing units	08 00813 20
811 L	1		08 00811 10
811 HL	1		08 00811 20
815	1		08 00815 20
815 L	1	For venturi dosing units	08 00815 40
815 XL	1		08 00815 60
Glass bottle	2	500 cc	08 02804 00
Glass bottle / cap / hose	3	For 909 and 909 HV	08 01804 00

Cast iron conditioning rings

We carefully select special high quality cast iron for optimum, durable results. Suitable for all lapping machines, whatever the brand or size. Available from stock or produced to order.



Compatible machines	Ø rings	Ø in mm		Height mm	Weight kg	Ref.	1 piece
		Ext.	Int.				
	14"	166	130	45,5	2,28	U166 A0355	
MM 8400 (Ø 381 mm)	15"	178	140	45,5	2,97	U178 A0381	
MM 9480 S (Ø 480 mm)	19"	218	182	45,5	4,20	U218 A0480	
MM 8600 (Ø 610 mm)	24"	286	248	70	7,84	U286 A0610	
MM 9700 (Ø 700 mm)	27"	315	275	70	9,24	U315 A0711	
	36"	419	368	100	20,8	U419 A0914	
MM 9100 (Ø 1000 mm)	40"	457	406	100	24	U457 A1000	
MM 9120 (Ø 1200 mm)	48"	545	480	100	36,6	U545 A1219	
MM 9120 (Ø 1200 mm)	(4x) 48"	510	432	125	41	U510 A1219	
MM 9150 (Ø 1500 mm)	59"	685	605	125	55	U685 A1500	

SPYLAP®



Ceramic conditioning rings with SPYLAP®

Prevent mechanical distortion problems. The ceramic rings enable you to preserve the flatness of the plate, to manage its heating, as well as limiting contamination thanks to the absence of graphite. The SPYLAP® sensor enables the user to visually prevent a significant mechanical distortion of the lapping (or polishing) support and of the part to be lapped. The SPYLAP® permanently monitors the temperature of the support and changes from black to red at a precisely predefined temperature.

Compatible machines	Ø rings	Ø in mm		Height mm	Weight kg	Ref.	1 piece
		Ext.	Int.				
	12"	140	106	41	0,83	08 83062 10	
MM 8400 (Ø 381 mm)	15"	182	140	41	2,42	08 83562 10	
MM 9480 S (Ø 480 mm)	19"	224	182	43,5	3,20	08 94803 00	
MM 8600 (Ø 610 mm)	24"	290	248	46	4,75	08 86562 10	
MM 9700 (Ø 700 mm)	27"	317	275	51	5,83	08 87562 10	
MM 9100 (Ø 1000 mm)	40"	450	406	81	15,60	08 81062 10	
MM 9120 (Ø 1200 mm)	48"	544	480	81	24,31	08 81262 10	

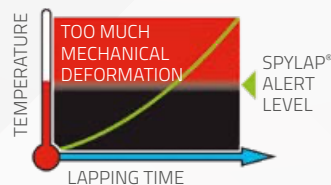

Standby



Alert

Plastic rings



Compatible machines	Ø rings	Ø in mm		Height mm	Weight kg	Ref.	1 piece
		Ext.	Int.				
	12"	140	106	41	0,73	08 83012 00	
MM 8400 (Ø 381 mm)	15"	182	140	41	2,13	08 83512 00	
MM 9480 S (Ø 480 mm)	19"	224	183	43,5	2,84	09 94803 20	
MM 8600 (Ø 610 mm)	24"	290	248	46	4,26	08 86512 00	
MM 9700 (Ø 700 mm)	27"	317	275	51	5,32	08 87512 00	
MM 9100 (Ø 1000 mm)	40"	450	406	81	14,75	08 87012 00	
MM 9120 (Ø 1200 mm)	48"	544	480	81	22	08 87262 00	

ACCESSORIES

Protection discs 881 and 883 series

Designation	Qty.	Dim. (mm)	Ref.
Protection discs 881 series Thickness: 1.4 mm	10	138	08 83501 00
	10	180	08 94801 00
	10	245	08 86001 00
	10	275	08 87501 00
	10	406	08 81001 00
	10	480	08 81201 00
Compensation discs 883 series	3	138	08 83503 00
	3	180	08 94803 10
	3	245	08 86003 00
	3	275	08 87503 00
	3	406	08 81003 00
	3	480	08 81203 00



881 series



883 series

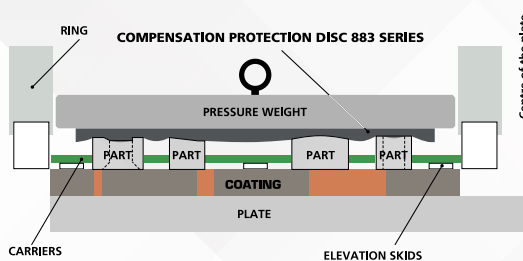
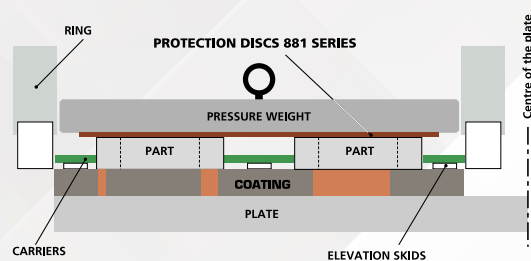

Holder discs 885 series

Anti-slipping holder disc for parts with a small, thickness 4 mm.

Designation	Qty.	Dim. (mm)	Ref.
Holder discs	3	138	08 83505 00
	3	180	08 94805 00
	3	245	08 86005 00
	3	275	08 87505 00
	3	406	08 81005 00
	3	480	08 81205 00

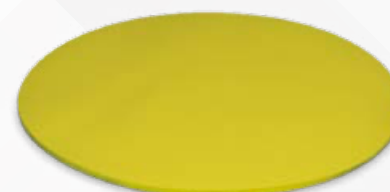

885 series

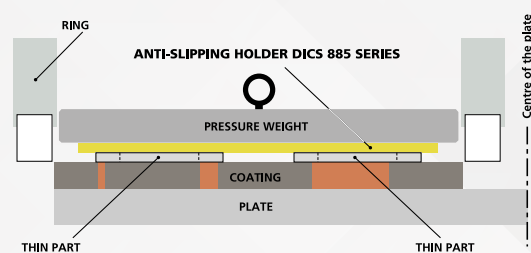

FAS[®] system

PLATES WITH ANTI-ADHESION COATING FOR SELF-ADHESIVE SUPPORT

Self-adhesive support

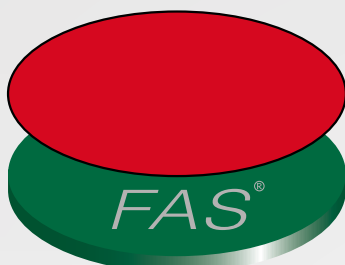

FAS[®] Plate

Designation	Qty.	Ø in mm	Ref.
FAS [®] plate	1	381	09 FAS00 40
	1	400	09 FAS00 80
	1	480	09 FAS00 30
	1	610	09 FAS00 60
	1	700	09 FAS00 70

TREATMENT OF YOUR PLATES WITH THE FAS[®] COATING

Designation	Qty.	Ø in mm	Ref.
FAS [®] plate coating	1	80	09 FASOR 02
	1	220	09 FASOR 05
	1	250	09 FASOR 10
	1	300	09 FASOR 50
	1	381	09 FASOR 40
	1	400	09 FASOR 80
	1	480	09 FASOR 30
	1	500	09 FASOR 51
	1	520	09 FASOR 52
	1	610	09 FASOR 60
	1	700	09 FASOR 70
	1	910	09 FASOR 90
	1	1000	09 FASOR 100

Other diameters on request

FIXING[®] discs

Semi-flexible support disc: 1 self-adhesive side. Allow easy sticking and unsticking of large self-adhesive polishing supports.

Self-adhesive support

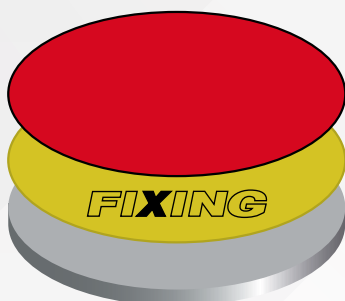

Metal plate

Designation	Qty.	Ø in mm	Ref.
FIXING [®] discs	5	381	TFIX 603 80
	5	400	TFIX 604 00
	1	480	TFIX 604 80
	1	550	TFIX 605 50
	1	610	TFIX 606 10
	1	700	TFIX 607 00
	1	914	TFIX 609 14

Specific carriers

CARRIERS SERIES 884 FOR SINGLE SIDE MACHINES

Easily usable plastic disc holding your parts during the lapping process. 3mm thick.
On demand, PMMA carriers are delivered with honeycomb cells according to the dimension of your parts.

Designation	Qty.	Dim. (mm)	Ref.
PVC carriers for the production of holding grids	3	138	08 83504 00
	3	180	08 94804 00
	3	245	08 86004 00
	3	275	08 87504 00
	3	406	08 81004 00
	3	480	08 81204 00
Skids	600	Ø 12	UPAT 012AC



CARRIERS FOR DOUBLE-SIDE MACHINES

The carriers are used to maintain the parts on the double-side machine. Their conception is realised according to the geometry of your parts or according to your drawings. Our carriers are available in a wide range of thickness, from a few millimetres to 200 µm.

Depending on your application and the nature of your parts, we propose our carriers in a large range of materials, such as stainless steel, blue steel (hardened until 600 Hv), glass fibre, aramid, PVC, epoxy,... For any double-side machine brand.

Designation
Epoxy carrier
PVC carrier
Metallic carrier

Avantages

- Excellent flatness and parallelism
- Quality of cuts
- Very low thickness dispersal
- Cuts atypical forms.

Exemples of application domain

- Optical
- Watchmaking
- Mechanic industry
- LED and semi-conductors.



Fixpad® system

FIXPAD® is a tool that allows simple and fast positioning of polishing discs on the plates of double-side machines.

Developed by LAM PLAN, FIXPAD® allows you to stick the discs to the plate without trapping air bubbles and without folds. Due to its design and thanks to the pre-cut TOUCHLAM® discs, the installation of discs on the upper plates is carried out in just seconds. The FIXPAD® pins guide the positioning of the pad when inserted in the distribution holes of the upper plate. This tool will simplify the installation of polishing pads and will limit machine stoppage time.

Designation	Ref.
FIXPAD® System for double-side machine	970203300

FIXPAD

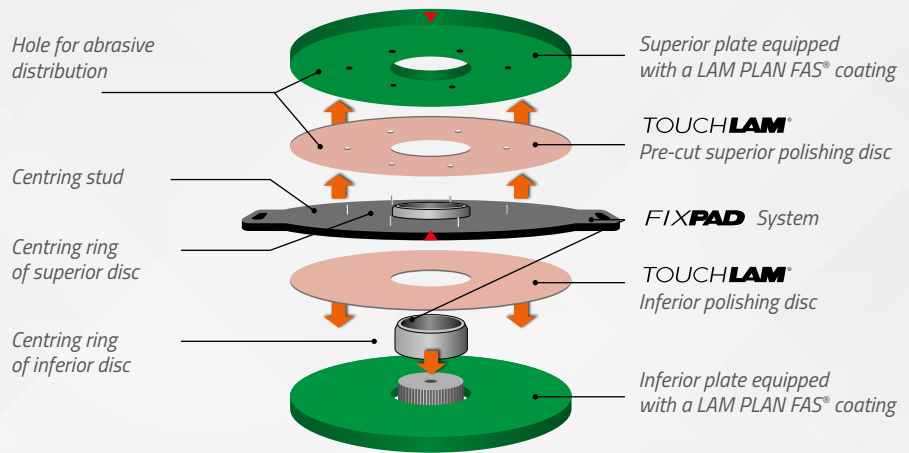

ACCESSORIES

Micrometric gauges

For a fast and precise check of your lapping plates, with a direct reading of the measurements. Precision: 1 µm. Each set includes:

- 1 marble, accuracy : 0,8 µm.
- 1 gauge made of stabilised aluminium or stainless steel for machines Ø 200 to 600 mm.
- 1 micron comparator.
- 1 transport and storage case.
- 1 user guide with charts and mapping formulas.

Designation	Qty.	Ref.
For machine Ø 200 to 400 mm	1	08 00898 00
For machine Ø 400 to 600 mm	1	08 00899 10
For machine Ø 610 mm	1	08 00892 00
For machine Ø 700 mm	1	08 00894 00
For our machine Ø 1000 mm	1	08 00893 00
For machine Ø 1200 mm	1	08 00895 00
For machine Ø 1500 mm	1	08 00897 00



Micrometric gauge
for Ø 200 to 600 mm machines

Monochromatic lamp

The use of a monochromatic lamp and an optical flatness gauge allow a simple reading of the geometry of your parts for their flatness check. The light from the low pressure sodium vapour bulb has a specific wavelength compatible with LAM PLAN's optical gauge.

Control capacity	Gauge with a 150 mm Ø maximum
L x P x D	280 x 330 x 390 mm
Equipment	Mirror delivered as standard to check deformable parts

Designation	Qty.	Ref.
Monochromatic lamp	1	08 00801 00
Spare bulb	1	08 00801 90



Monochromatic lamp and optical gauges



Removable,
also usable
in its support

Optical gauges

Our new range of quartz optical gauge is also available on demand with boring or in a rectangular shape..

Ø in mm	Thickness in mm	Number of faces	Accuracy	Ref.
50	10	1	Lambda/10	08 01805 00
75	15	1	Lambda/10	08 01807 00
100	17	1	Lambda/10	08 01810 00
125	20	1	Lambda/10	08 01812 00
150	25	1	Lambda/10	08 01814 00
200	30	1	Lambda/10	08 01820 00
250	35	1	Lambda/10	08 01825 00
300	40	1	Lambda/10	08 01830 00
50	10	2	Lambda/10	08 00805 00
75	15	2	Lambda/10	08 00807 00
100	17	2	Lambda/10	08 00810 00
125	20	2	Lambda/10	08 00812 00
150	25	2	Lambda/10	08 00814 00
200	30	2	Lambda/10	08 00820 00
250	35	2	Lambda/10	08 00825 00
300	40	2	Lambda/10	08 02830 00



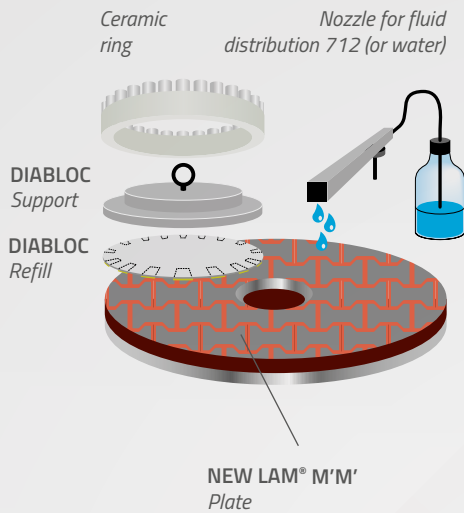

Plate maintenance and integrated reconditioning and grooving system

DIABLOC SYSTEM

The reconditioning of composite plates can be carried out in different ways.

The DIABLOC is a self-adhesive disc which has a series of diamond pellets. It is stuck onto a stable and lapped aluminium support. It allows the reconditioning of NEW LAM®M'M', EVOLAM ULTIMATE and 2000 series plates. It corrects distortion and surface faults (glazing, scratching) of your plates. The new VIOLET and BLACK DIABLOCS are more aggressive, enabling you to accelerate the reconditioning phase notably on large diameter plates.

DIABLOCS

1 holder + 1 disc

Designation	For plate Ø	Ø in mm	Ref.	
	Ø 381 mm	178	08 00907 60	
DIABLOC BLACK Super aggressive.	Ø 480 mm	224	08 00907 64	
	Ø 610 mm	286	08 00907 70	
	Ø 700 mm	315	08 00907 90	
	For COMPOSITE rough lapping plates in great diametre.	Ø 914 mm	419	08 00907 80
	Ø 1000 mm	451	08 00907180	
	Ø 1200 mm 4 rings	500	08 00907500	
	Ø 1200 mm	545	08 00907 00	
	Ø 381 mm	178	08 00906 60	
	Ø 480 mm	224	08 00906 64	
	DIABLOC PURPLE Aggressive.	Ø 610 mm	286	08 00906 70
		Ø 700 mm	315	08 00906 90
	For COMPOSITE rough lapping plates.	Ø 914 mm	419	08 00906 80
		Ø 1000 mm	451	08 00906180
		Ø 1200 mm 4 rings	500	08 00906500
Ø 1200 mm		545	08 00906 00	
Ø 1500 mm			available on request	
	Ø 381 mm	178	08 00900 60	
	DIABLOC BLUE	Ø 480 mm	224	08 00900 64
		Ø 610 mm	286	08 00900 70
	For fine and super finish COMPOSITE lapping plates lapping plates in great diametre.	Ø 700 mm	315	08 00900 90
		Ø 914 mm	419	08 00900 80
		Ø 1000 mm	451	08 00900180
		Ø 1200 mm 4 rings	500	08 00900500
		Ø 1200 mm	545	08 00900 00
		Ø 381 mm	178	08 00901 60
		DIABLOC GREEN	Ø 480 mm	224
Ø 610 mm			286	08 00901 70
For fine and super finish COMPOSITE lapping plates.		Ø 700 mm	315	08 00901 90
		Ø 914 mm	419	08 00901 80
		Ø 1000 mm	451	08 00901180
		Ø 1200 mm 4 rings	500	08 00901500
		Ø 1200 mm	545	08 00901 00
Ø 1500 mm			available on request	

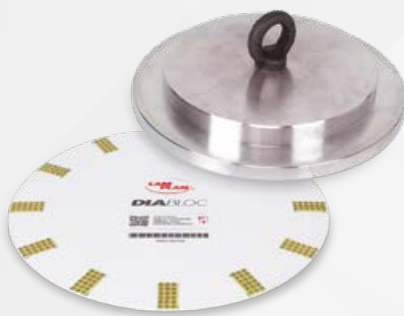





ACCESSORIES

Mains plate Ø	EVOLAM	NEW LAM M'M'			
	Ultimate	Blue	Green	Yellow	
381 mm (15")					
480 mm					
610 mm (24")					
700 mm					
914 mm (36")					
1000 mm					
1200 mm (48")					

GUIDANCE

Depending on the plate to be reconditioned, the right DIABLOC can be chosen

There are four variants designed with different degrees of aggressiveness:

	Black - super aggressive
	Purple - aggressive
	Blue DIABLOC - for finishing plate great diameter
	Green DIABLOC - for finishing plate

REFILLS FOR DIABLOCS

1 piece

Designation	For plate Ø	Ø in mm	Ref.
	Ø 381 mm	178	08 01907 60
REFILLS DIABLOC BLACK Super aggressive. For COMPOSITE rough lapping plates in great diameter.	Ø 480 mm	224	08 01907 64
	Ø 610 mm	286	08 01907 70
	Ø 700 mm	315	08 01907 90
	Ø 914 mm	419	08 01907 80
	Ø 1000 mm	451	08 01907 180
	Ø 1200 mm 4 rings	500	08 01907 500
	Ø 1200 mm	545	08 01907 000
	Ø 381 mm	178	08 01906 60
	Ø 480 mm	224	08 01906 64
	Ø 610 mm	286	08 01906 70
REFILLS DIABLOC PURPLE Aggressive. For COMPOSITE rough lapping plates.	Ø 700 mm	315	08 01906 90
	Ø 914 mm	419	08 01906 80
	Ø 1000 mm	451	08 01906 180
	Ø 1200 mm 4 rings	500	08 01906 500
	Ø 1200 mm	545	08 01906 000
	Ø 1500 mm		available on request
	Ø 381 mm	178	08 01900 60
	Ø 480 mm	224	08 01900 64
	Ø 610 mm	286	08 01900 70
	Ø 700 mm	315	08 01900 90
REFILLS DIABLOC BLUE For fine and super finish COMPOSITE lapping plates in great diameter.	Ø 914 mm	419	08 01900 80
	Ø 1000 mm	451	08 01900 180
	Ø 1200 mm 4 rings	500	08 01901 500
	Ø 1200 mm	545	08 01900 000
	Ø 381 mm	178	08 01901 60
	Ø 480 mm	224	08 01901 64
REFILLS DIABLOC GREEN For fine and super finish COMPOSITE lapping plates.	Ø 610 mm	286	08 01901 70
	Ø 700 mm	315	08 01901 90
	Ø 914 mm	419	08 01901 80
	Ø 1000 mm	451	08 01901 180
	Ø 1200 mm 4 rings	500	08 01901 500
	Ø 1200 mm	545	08 01901 000
	Ø 1500 mm		available on request



AUTOPLAN system

The AUTOPLAN system enables efficient plate flatness and grooving in order to create structures which modify its properties. The principle lies in plate machining with a moving cutting tool. The AUTOPLAN is positioned and mounted in a few minutes thanks to the dedicated fixation points integrated in our machines.



Dedicated to series 9000 machines

At present, the automatic AUTOPLAN system can be integrated in LAM PLAN machines up to model M.M.9100. It is installed on dedicated points on the machine structure. Driven directly by the control interface, you can manage forward speed in order to carry out flattening or grooving operations. The AUTOPLAN produces spiral grooving. This system is faster and more precise than the DIABLOC. It is also easier to manage and to reproduce the required support geometry (flat, concave or convex).

Production stoppage for plate reconditioning is reduced and productivity is increased.



AUTOPLAN FOR LAPPING MACHINES M.M.9000 SERIES

Designation	Ref.
AUTOPLAN for M.M.9100 version E, S, SR and EC with SUPPORT TROLLEY.	10 9100AP 00
AUTOPLAN for M.M.9700 version E, S and S HP with SUPPORT TROLLEY.	10 9700AP 00
AUTOPLAN for M.M.9480 version S with SUPPORT TROLLEY.	10 9480AP 00



ACCESSORIES

Washing stand

M.M.8057

Designation	Qty.	Ref.
Compact and economical washing stand - 15 L	1	08 00570 00



Protective film

Technical film with adhesive on one face.
Protects surfaces after polishing or treating processes.

Designation	Dim.	Qty.	Ref.
Protective film	30 cm x 100 m	1	Z000 G7BL1

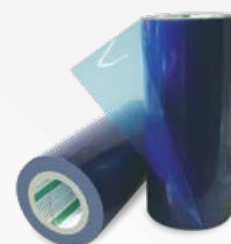

Cleaning products

STANOL BARREL

Solvent for washing stand.

Designation	Qty.	Ref.
Stanol barrel	60 litres	08 00614 00

DETERGENT 742

Concentrated detergent in aqueous phase used to degrease and clean parts after lapping or polishing cycles. This detergent with a high anticorrosion power is an excellent alternative to conventional cleaning solvents. Non inflammable, it is ideal for cleaning all types of materials (steels, cast irons, aluminium, etc.). Dilute 2 to 5% with water for use in ultrasonic cleaning tanks (40 to 55 °C) or 7 to 20% with water for fountain based cleanings.

Designation	Qty.	Ref.
Detergent 742	5 litres	08 01742 10
	30 litres	08 01742 30

DETERGENT 743

Aqueous detergent specifically adapted for the cleaning of ceramics, refractory materials and glasses. Dilute 1 volume of detergent in 9 volumes of water.

Designation	Qty.	Ref.
Detergent 743	5 litres	08 01743 10



SUPPORTS

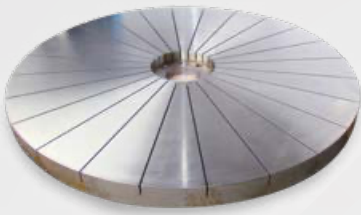

Cast iron plates

As a manufacturer and designer of cast iron plates and rings, we select specific high quality cast iron for optimum and long lasting results. AQUA LAM® plates and rings are suitable for all lapping machines of any brand or size. Available from stock or made to order within the shortest deadlines, AQUA LAM® cast iron plates and rings offer exceptional value for money.

Radial grooved cast iron plate with LAM PLAN adaptation system, other machine adaptations on request.

Dimension Ø	Thickness (according to lapping machine types)	Ref.
14" 355 mm	25 - 40 mm	V014RASTD
15" 381 mm	25 - 40 mm	V015RASTD
19" 480 mm	25 - 40 mm	V019RASTD
24" 610 mm	35 - 40 mm	V024RASTD
28" 700 mm	55 mm	V028RASTD
36" 914 mm	57 - 58 mm	V036RASTD
39" 1000 mm	57 - 60 mm	V040RASTD
1200 mm	70 mm	V047RASTD
48" 1219 mm	70 mm	V048RASTD
59" 1500 mm	80 - 100 mm	V059RASTD

AQUA LAM®

Lapping cast iron plates with radial grooving by default, available on request in full or with all types of grooves, Concentric, Helical and Linear.

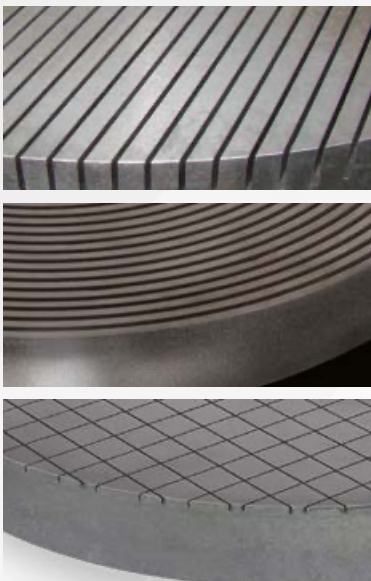

LAM PLAN, designer and manufacturer of a full range of lapping and polishing supports to cover all your requirements in terms of material removal, surface finish and flatness.

LAPPING SUPPORTS

NEW LAM® M'M' plates

25 years ago, LAM PLAN designed the patented NEW LAM® M'M' poli-lapping system. Since then LAM PLAN has constantly made its process evolve to respond to the technical requirements of its customers. The system patented and established in production plants throughout the world is today a must in the lapping polishing process.

The NEW LAM® M'M' plate, uses free diamond abrasives for its operation. As soon as the plate starts rotating, under the effect of the initial weight of the parts and the load applied by the machine's jacks, the diamond grains move and fix on the surface of the plate producing a unique abrasive action on the side of the parts to be lapped.

The patent

The disposition and the shape of the two components of the plate permit an optimum alternation between the hard areas and the soft areas. The cut angle of the diamond grains is permanently changed, which ensures a large stock removal and a perfect inherent flatness.

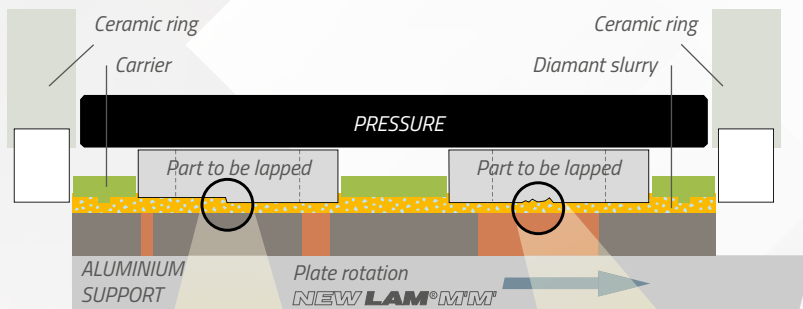

NEW LAM® M'M'

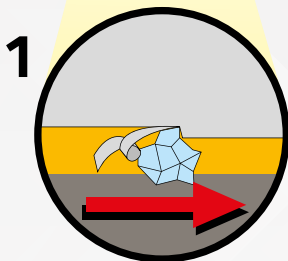
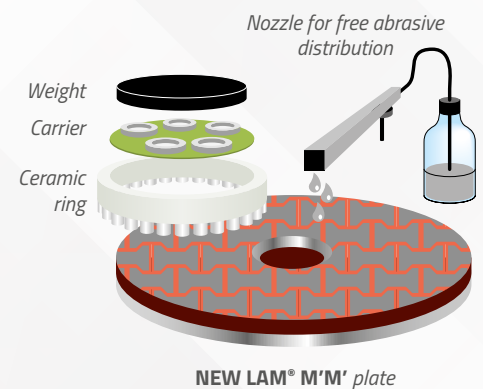

1
The free diamond contained in the abrasive film is momentarily fixed in the plate's hard material; when they are solid with each other, they produce a cut off effect which favours the stock removal.

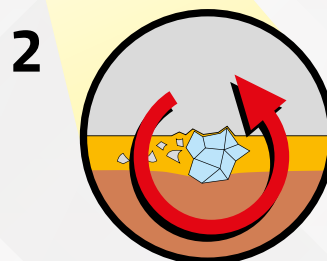

2
In contact with the plate's soft material, the free diamond is driven in, while remaining mobile, and removes the material by impact; it is the stock effect which contributes to the quality of the surface condition.

NEW LAM® M'M' patented plates

BLUE - ROUGH LAPPING



Ø	Thickness	Ø central bore	Standard		Incorporated cooling circuit
			Ref.	Ref.	
14"	355 mm	13 mm		09 NL103 20	
15"	381 mm	13 mm	100 mm	09 NL103 30	09 NL203 30
16"	406 mm	13 mm	100 mm	09 NL103 40	
19"	480 mm	13 mm	100 mm	09 NL103 55	
24"	610 mm	15 mm	115 mm	09 NL103 60	09 NL203 60
27"	700 mm	15 mm	150 mm	09 NL103 70	09 NL203 70
30"	762 mm	15 mm	152 mm	09 NL103 80	
36"	914 mm	15 mm	175 mm	09 NL103 90	
1000 mm	15 mm	188 mm		09 NL103 00	09 NL203 00
1200 mm	15 mm	240 mm		09 NL103 50	09 NL203 50
1500 mm	15 mm	300 mm		09 NL103 10	09 NL203 10

GREEN - FINE LAPPING/POLISHING



Ø	Thickness	Ø central bore	Standard		Incorporated cooling circuit
			Ref.	Ref.	
14"	355 mm	13 mm		09 NL106 20	
15"	381 mm	13 mm	100 mm	09 NL106 30	09 NL206 30
16"	406 mm	13 mm	100 mm	09 NL106 40	
19"	480 mm	13 mm	100 mm	09 NL106 55	
24"	610 mm	15 mm	115 mm	09 NL106 60	09 NL206 60
27"	700 mm	15 mm	150 mm	09 NL106 70	09 NL206 70
30"	762 mm	15 mm	152 mm	09 NL106 80	
36"	914 mm	15 mm	175 mm	09 NL106 90	
1000 mm	15 mm	188 mm		09 NL106 00	09 NL206 00
1200 mm	15 mm	240 mm		09 NL106 50	09 NL206 50
1500 mm	15 mm	300 mm		09 NL106 10	09 NL206 10

YELLOW - SUPER FINISHING POLISHING



Ø	Thickness	Ø central bore	Standard		Incorporated cooling circuit
			Ref.	Ref.	
14"	355 mm	13 mm		09 NL105 20	
15"	381 mm	13 mm	100 mm	09 NL105 30	09 NL205 30
16"	406 mm	13 mm	100 mm	09 NL105 40	
19"	480 mm	13 mm	100 mm	09 NL105 55	
24"	610 mm	15 mm	115 mm	09 NL105 60	09 NL205 60
27"	700 mm	15 mm	150 mm	09 NL105 70	09 NL205 70
30"	762 mm	15 mm	152 mm	09 NL105 80	
36"	914 mm	15 mm	175 mm	09 NL105 90	
1000 mm	15 mm	188 mm		09 NL105 00	09 NL205 00
1200 mm	15 mm	240 mm		09 NL105 50	09 NL205 50
1500 mm	15 mm	300 mm		09 NL105 10	09 NL205 10

EVOLAM® composite plates

A plate for 3 steps

The new EVOLAM® ULTIMATE and EVOLAM® lapping plates have been specially developed for hard materials such as sapphire and technical ceramics. The specific composition of these plates gives them an excellent stock removal combined with a low roughness. A poly-lapping operation with our EVOLAM® plates allows to obtain the superfinishing stage in only one step.

A C or H groove is generally made on EVOLAM® plates to increase their performance.

EVOLAM®

NEW

∅	Type	Thickness	Ref.
15" 381 mm	ULTIMATE	8 mm	09 EL154 30
19" 480 mm	ULTIMATE		09 EL154 55
24" 610 mm	ULTIMATE		09 EL154 60
700 mm	ULTIMATE		09 EL154 70
30" 762 mm	CLASSIC	13 mm	09 EL104 80
36" 914 mm	CLASSIC		09 EL104 90
1000 mm	CLASSIC		09 EL104 00
1200 mm	CLASSIC		09 EL104 50
1500 mm	CLASSIC		09 EL104 10



EVOLAM® ULTIMATE



EVOLAM® classic

GUIDANCE

Positioning of LAM PLAN composite lapping plates

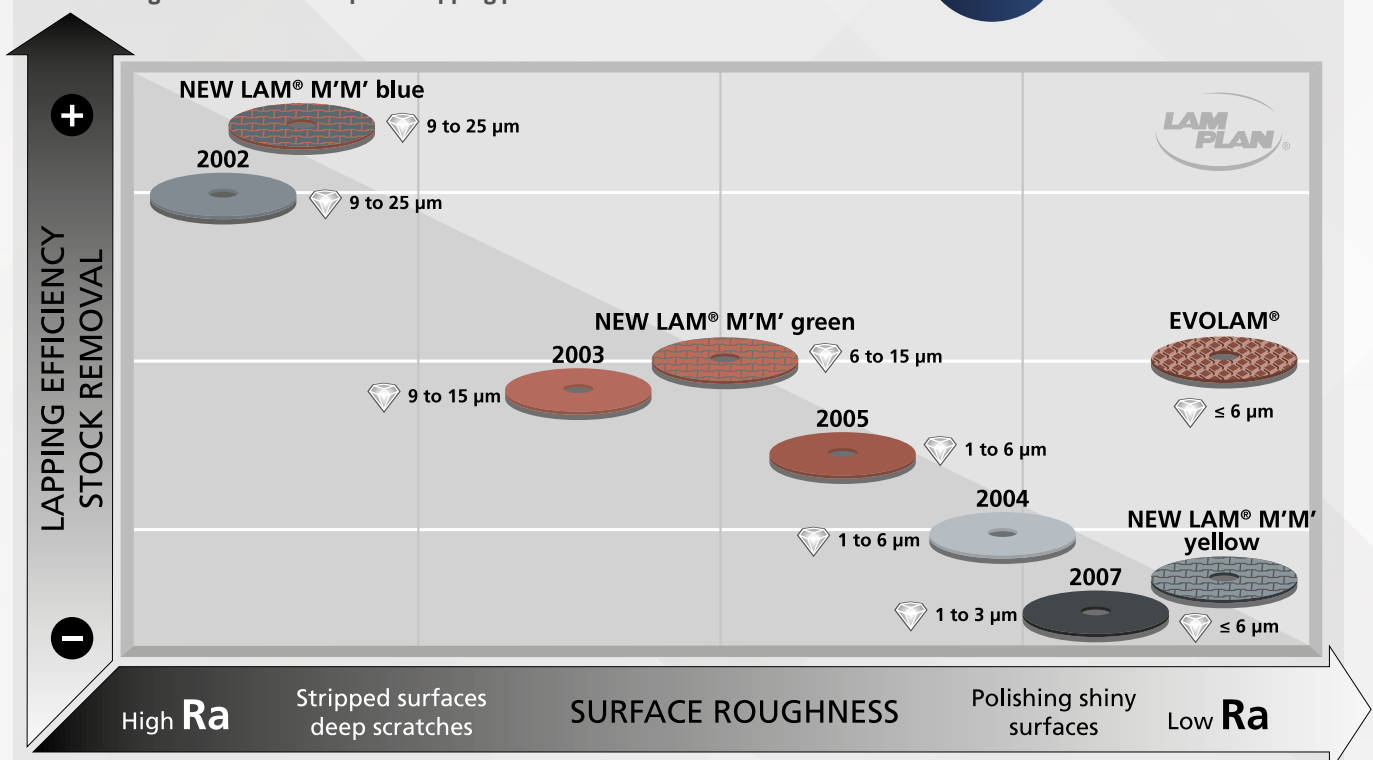



Different kinds of grooves

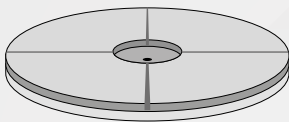

Radial (R)

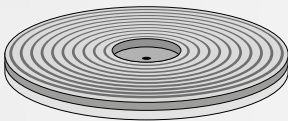

Concentric (C)

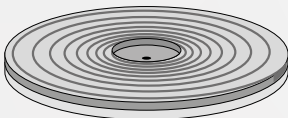

Spiral (S)

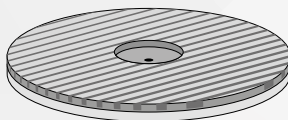

Linear (L)

Series 2000 mono-component plates

Primarily used during pre-polishing phases these plates allow a surface condition which facilitates the finishing step on polishing cloths to be obtained.

Available in solid version or to order with radial, concentric, spiral or linear grooving.

2006 - MIDDLE & FINE LAPPING POLISHING - ALL MATERIALS

For abrasive 6 µm to 1 µm		
∅	Thickness	Ref.
15" 381 mm	13 mm	09 P2006 30
19" 480 mm		09 P2006 55
24" 610 mm		09 P2006 60
700 mm		09 P2006 70
1000 mm		09 P2006 00

2001 - FINE LAPPING - HARD MATERIAL

For abrasive 15 µm to 1 µm		
15" 381 mm	6 mm	09 P2001 30
19" 480 mm		09 P2001 55
24" 610 mm		09 P2001 60
700 mm		09 P2001 70
1000 mm		09 P2001 00

2002 - ROUGH LAPPING - ALL MATERIALS

For abrasive 30 µm to 15 µm		
15" 381 mm	13 mm	09 P2002 30
19" 480 mm		09 P2002 55
24" 610 mm		09 P2002 60
700 mm		09 P2002 70
1000 mm		09 P2002 00

2003 - FINE LAPPING - ALL MATERIALS

For abrasive 9 µm to 3 µm		
15" 381 mm	13 mm	09 P2003 30
19" 480 mm		09 P2003 55
24" 610 mm		09 P2003 60
700 mm		09 P2003 70
1000 mm		09 P2003 00

2005 - SUPER FINISHING POLISHING - ALL MATERIALS

For abrasive 3 µm to 1 µm		
15" 381 mm	13 mm	09 P2005 30
19" 480 mm		09 P2005 55
24" 610 mm		09 P2005 60
700 mm		09 P2005 70
1000 mm		09 P2005 00

2007 - SUPER FINISH POLISHING - ALL MATERIALS

For abrasive 2 µm to 1 µm		
15" 381 mm	13 mm	09 P2007 30
19" 480 mm		09 P2007 55
24" 610 mm		09 P2007 60
700 mm		09 P2007 70
1000 mm		09 P2007 00

LAPPING SUPPORTS

Manual lapping & polishing plates

Extend the usage of your sealing parts.

LAMBLOCK are simple, inexpensive and easy to use tools that will allow preventive maintenance of sealing parts on industrial sites at a lower cost. Your maintenance department carries out manual lapping/polishing operations to recondition worn sealing parts.

BI-LAMBLOCK

2 Operations: Lapping and Polishing for the servicing of sealing part up to Ø 40 mm.

Designation	Ø in mm	Ref.
- 1 ergonomic double plate - Grey lapping / Copper polishing - 2 diadosers Bio DIAMANT® 400 series of 30 g	300	09 04LB9 00

LAMBLOCK NEW LAM®M'M' PLATE

Lapping with the guarantee of a perfect flatness for parts with a Ø 40 mm max and rings with a Ø 70 mm max.

Designation	Ø in mm	Ref.
- 1 NEW LAM M'M' plate - 1 Dosing-stick Bio DIAMANT® 10 g - 1 fluid bottle lubricant M.M.712	LAMBLOCK Blue - Lapping 300	09 04LB0 00
	LAMBLOCK Green - finishing 300	09 04LB1 00
	LAMBLOCK Yellow - Super finishing 300	09 04LB2 00

LAMBLOCK FAS®

NEW

Portable plate with non-stick LAM PLAN FAS® coating for use with the range of self-adhesive TOUCHLAM® discs. Combined with LAM PLAN abrasives, it is an economical solution for finishing and super-finishing steps on all materials.

Designation	Ø in mm	Ref.
- 1 plate with FAS® coating - 2 diadosers Bio DIAMANT® 400 series 30 g 3 and 6µ	300	09 04LB3 00

TRI-BLOCS NEW LAM®M'M' CASE

3 operations: lapping, polishing and superfinishing, for the servicing of your sealing rings up to Ø 40 mm.

Designation	Ø in mm	Ref.
- 3 NEW LAM® M'M' plates - 3 dosing sticks Bio DIAMANT® 10 g - 1 bottle of fluid lubricant M.M.712 - 1 Diabloc for reconditioning	140	09 03NL0 00
Blue Diabloc for TRI-BLOCS		08 00900 10
Blue Diabloc refill		08 01900 10



Temperature control system

Flat lapping is based on the laws of mechanics and physics where a constant temperature is essential.

Temperature variations of a lapping plate, whether inherent in the lapping process or dependent on external conditions, can be detrimental to the quality of the desired result. To avoid such damage, the use of our plates at high yield NEW LAM M'M' requires the use of a temperature control system.

COMPOSITE LAM PLAN plates with an integrated cooling system ensure temperature fluctuation control during series production. This option enables avoidance of plate distortion and consequently, distortion of your pieces.

To control the flatness of the trays, the temperature must be controlled

P803 Regulator

To control plate flatness, temperature must be regulated. The LAM PLAN P803 temperature regulation unit is reversible. It can also raise the plate temperature before use. This enables lapping to start in optimum geometric conditions in any work environment.

The P803 regulator is designed to maintain the temperature between 2 set values. It is an autonomous machine which has its own command interface.

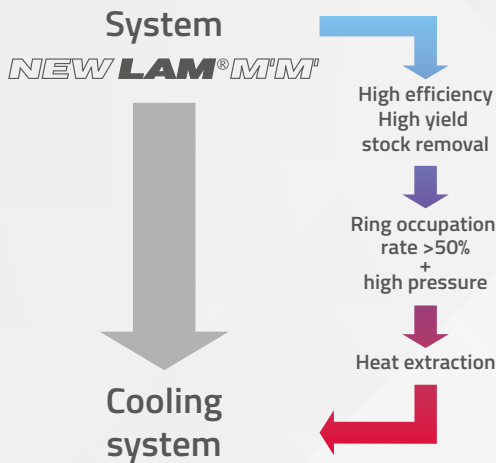

NEW LAM M'M' plate with temperature control system

The LAM PLAN cooling system captures calories directly under the active plate surface. It is adaptable for all machines.

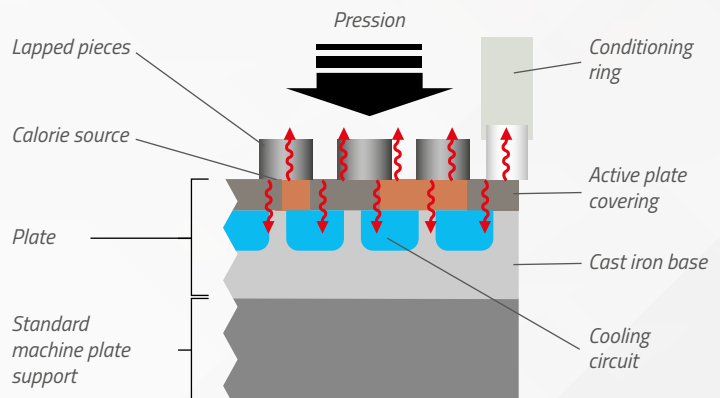
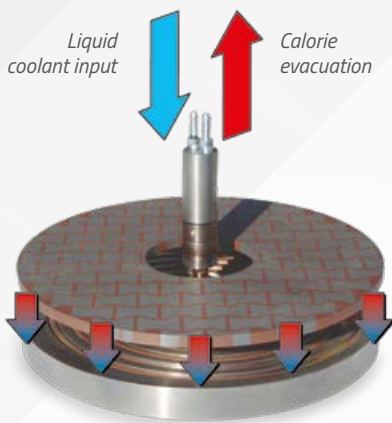

Lapping rods M.M.®

Immediately shape your rods in all form, from patented M.M.® preliminary shape containing no abrasive.



Applications

For internal and external lapping, and super finishing of spherical, conical and cylindrical parts and many other shapes.

The solution

LAM PLAN offers an original, functional and adapted solution; it responds to the requirements of surface conditions difficult to attain with tools or grinding wheels. LAM PLAN delivers its rods in preliminary shape condition. The user finalises the form of his choice. A fast machining using common tools (never a grinding wheel) allows adapting the rods to the shape of the parts to be lapped. This technique is possible thanks to the LAM PLAN M.M.® system which combines rods and free diamond abrasives.

The technique

The LAM PLAN M.M.® rods consists of two different materials in terms of mechanical, physical and resistance characteristics. The composition and arrangement of the two components associated with the usage of specific diamond abrasive is the base of the patented LAM PLAN M.M.® system and its effectiveness.

The advantages of the LAM PLAN M.M.® system associated with Bio DIAMANT®

The LAM PLAN M.M.® system uses special abrasives. A chemical binder allows homogeneous, stable distribution of calibrated diamond grains, while preventing any settling phenomenon. As soon as the rod starts rotating under the effect of the applied pressure and the passage on the two different materials, the diamond grains move and fix alternatively. This causes a phenomenon of significant acceleration of these particles ensuring a high stock removal. Penetrating very low and for a very short time in the rod's metal mass, each diamond particle always presents an edge opposite to the part to be machined.

All the cutting edges work under an over speed. The abrasive's efficiency is therefore better and more sustainable.

In addition, thanks to the use of diamond, the rod coating does practically not wear out (good behaviour in terms of shape or inherent flatness).

The LAM PLAN type M.M.® lubricant vaporised in a very small quantity allows cleaning the diamond's cutting edges loaded with metal waste and operates cooling action.

The small quantity of lubricant significantly reduces the "machining sludge" volume. The work is cleaner and produces less waste.

Qualities

In order to obtain surface conditions varying from 0.2 to 0.01 micron/Ra, LAM PLAN proposes various types of rods. The distribution of the 2 materials which make up the patented bi-component rods type M.M.® remains constant, regardless of the shape given to them. The rods type 2000 are mono-components. They benefit from the quality of bi-component materials, but their efficiency is lower and their wear more rapid.



Shapes	Preliminary shapes	A cylindrical
		B flat
		C rectangular
Types	Patented M.M. Rods Bi-components	M.M.® 980 lapping
		M.M.® 991 finishing
		M.M.® 992 superfinishing
	Economic range Mono-component	2002 lapping
		2003 polishing



RODS M.M.® SHAPE A

Cylindrical preliminary shape intended to be machined by turning with a dry carbide tool in order to adapt to the parts to be treated.

Implementation example				
Lapped part	Material	Rod	Abrasive	Result
Cupule for thigh prosthesis	Chromium cobalt	Shape A Type 992	Stick M.M.143	Sphericity 3 µm

LAPPING SUPPORTS

RODS M.M.® SHAPE B

Our Shape B rods are composed of a 5mm active part fixed to a steel* ensuring great rigidity. Please contact us for dimensions above 200 mm. To machine the rods and use them, the shapes A or B must be tightened in a mandrel one turn mounted on a metal rod (by tapping or gluing).

NOT: The tapping must always remain below the steel* thickness in the case of shapes B. In any case (shapes A or B), the centre of the coating has to be cleared to avoid the dead point. During shaping, it is recommended to recover the chips and dusts to reduce the cleaning time.

*aluminium base on demand

Implementation example

Lapped part	Material	Rod	Abrasive	Result
Safety valve	Satellite	Shape B Type 991	Stick M.M.141	Tightness

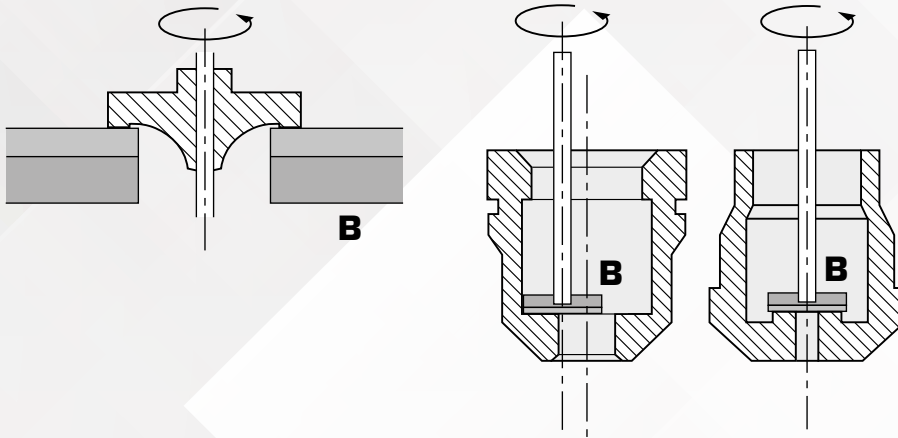
**LAPIDARY M.M.® SHAPE C**

Intended to prepare the rods for the machine of special shaped parts.

Implementation example

Lapped part	Material	Rod	Abrasive	Result
Rolling machine cylinder	Cast iron	Shape C Type 980	Stick M.M.133	Roughness Ra 0,08

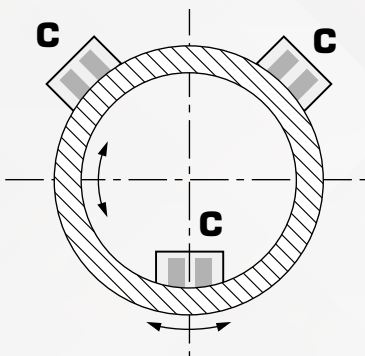

RODS SHAPE A

Type	Ø in mm	Ref.
991	25 x 100	09 09991 28
992	25 x 100	09 09992 28
2002	25 x 100	09 20022 20
2003	25 x 100	09 20032 20
980	50 x 50	09 09980 10
991	50 x 50	09 09991 10
992	50 x 50	09 09992 10
2002	50 x 50	09 20021 10
2003	50 x 50	09 20031 10
2002	50 x 100	09 20022 10
2003	50 x 100	09 20032 10
2002	50 x 150	09 20023 10
2003	50 x 150	09 20033 10
980	75 x 50	09 09980 80
991	75 x 50	09 09991 80
992	75 x 50	09 09992 80
2002	75 x 50	09 20021 80
2003	75 x 50	09 20031 80
2002	75 x 100	09 20022 80
2003	75 x 100	09 20032 80
2002	75 x 150	09 20023 80
2003	75 x 150	09 20033 80
2002	100 x 50	09 20021 90
2003	100 x 50	09 20031 90
2002	100 x 100	09 20022 90
2003	100 x 100	09 20032 90
2002	100 x 150	09 20023 90
2003	100 x 150	09 20033 90

RODS SHAPE B

Type	Ø in mm	Ref.
980	50 x 15	09 09980 30
991	50 x 15	09 09991 30
992	50 x 15	09 09992 30
2002	50 x 15	09 02002 30
2003	50 x 15	09 02003 30
980	100 x 15	09 09980 40
991	100 x 15	09 09991 40
992	100 x 15	09 09992 40
2002	100 x 15	09 02002 40
2003	100 x 15	09 02003 40
980	150 x 15	09 09980 50
991	150 x 15	09 09991 50
992	150 x 15	09 09992 50
2002	150 x 15	09 02002 50
2003	150 x 15	09 02003 50
980	200 x 15	09 09980 60
991	200 x 15	09 09991 60
992	200 x 15	09 09992 60
2002	200 x 15	09 02002 60
2003	200 x 15	09 02003 60

RODS SHAPE C

3 pieces

Type	Ø in mm	Ref.
980	10 x 20 x 560	09 08445 30
991	10 x 20 x 560	09 08446 30
992	10 x 20 x 560	09 08449 30

CUSTOM MACHINING PACKAGE

NEW

Designation	Qty.	Ref.
Custom machining package	1	99 SAV0F 00

GUIDANCE

Example of implementation

Type	Rods	Sticks	Gels	Treated steel		Tungsten carbide		Stellite	
				Surface condition µm Ra	Stock removal	Surface condition µm Ra	Stock removal	Surface condition µm Ra	Stock removal
Rough	M.M.980	M.M.131	M.M.31	0,3	6 µm/min	0,1	2,4 µm/min	0,15	4 µm/min
	M.M.980	M.M.132	M.M.32	0,2	3 µm/min	0,07	1,5 µm/min	0,09	2 µm/min
Finishing	M.M.991	M.M.133	M.M.33	0,09	1,6 µm/min	0,03	0,7 µm/min	0,05	1,2 µm/min
	M.M.991	M.M.141	M.M.41	0,06	1,3 µm/min	0,02	0,5 µm/min	0,03	0,6 µm/min
Super finishing	M.M.992	M.M.142	M.M.42	0,05	1 µm/min	0,01	0,4 µm/min	0,02	0,5 µm/min
	M.M.992	M.M.143	M.M.43	0,03	0,6 µm/min	0,005	0,3 µm/min	0,01	0,4 µm/min

The Sticks and gels used for an everyday usage are put in bold letters.

Expandable cylindrical rods

The formula for the accuracy of borings. The set is composed of:

- A conical shaft to be mounted on the mandrel.
- A cast iron rod with pinched structure. A helical slot allows the expansion while maintaining its geometric shape. The rod's interior is conical in order to receive the shaft.
- A tube-shaped pushrod is here allows driving the rod on the shaft.

Procedure

The abrasive to be used with the rods is selected according to their tasks:

- Important stock removal: diamond dosing stick M.M.132
 - Super-finishing: diamond dosing stick M.M.142 or 144.
- Lubrication thanks to the M.M.712 fluid.

Use

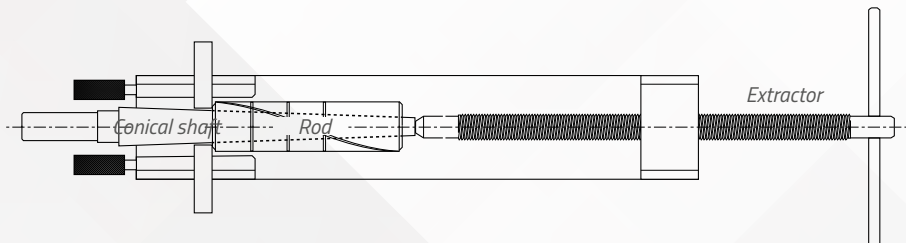
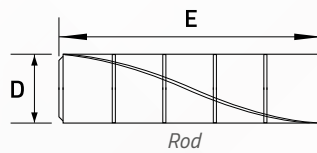
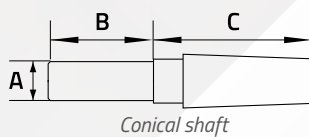
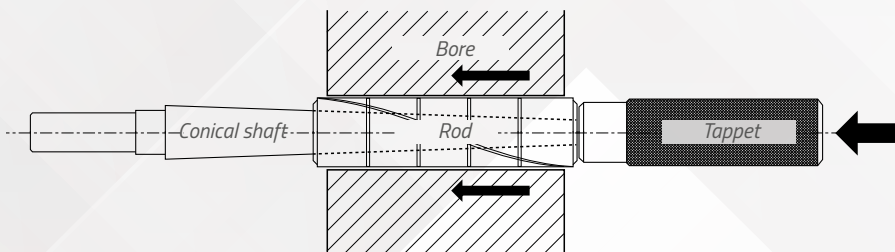

Results

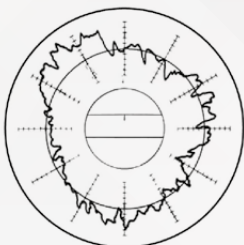

A 15,9 mm diameter has been drilled on a 38 mm length. After checking, an ovalisation of 4/100th mm has been revealed and a surface condition of 0.5-micron Ra.

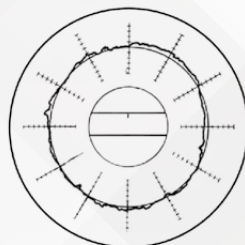

First operation
With rod and diamond dosing stick M.M.132: ovalisation reduced to 4/10th micron, surface condition of 0.12-micron Ra.

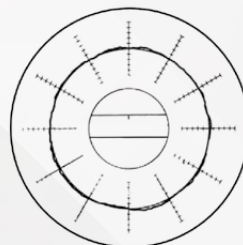

Second operation
With rod and diamond dosing stick M.M.144: limited ovalisation to 1/10th micron. Surface condition to 0.03-micron Ra.



RODS

CONICAL SHAFTS

TAPPETS

Ø (mm)	Lenght E (mm)	Expansion D (mm)	Ref.	N°	Ø A (mm)	Lenght. B (mm)	Lenght C (mm)	Ref.	N°	Ref.
1,19	12,70	1,168 à 1,397	99 91011 90	4/0	3,17	19,05	38,10	99 92004 00	4/0	99 93004 00
1,59	15,85	1,574 à 1,930	99 91015 90	3/0	3,17	19,05	39,10	99 92003 00	3/0	99 93003 00
1,98	15,85	1,956 à 2,311	99 91019 80	3/0	3,17	19,05	39,10	99 92003 00	3/0	99 93003 00
2,38	19,05	2,362 à 2,743	99 91023 80	2/0	3,17	19,05	41,25	99 92002 00	2/0	99 93002 00
2,78	19,05	2,743 à 3,099	99 91027 80	2/0	3,17	19,05	41,25	99 92002 00	2/0	99 93002 00
3,17	22,19	3,149 à 3,479	99 91031 70	0	3,17	19,05	44,45	99 92000 00	0	99 93000 00
3,57	22,19	3,530 à 3,886	99 91035 70	0	3,17	19,05	44,45	99 92000 00	0	99 93000 00
3,97	22,19	3,937 à 4,318	99 91039 70	0	3,17	19,05	44,45	99 92000 00	0	99 93000 00
4,37	22,19	4,318 à 4,673	99 91043 70	0	3,17	19,05	44,45	99 92000 00	0	99 93000 00
4,76	34,91	4,724 à 5,105	99 91047 60	1	4,74	25,40	69,85	99 92000 10	1	99 93000 10
5,16	34,91	5,130 à 5,461	99 91051 60	1	4,74	25,40	69,85	99 92000 10	1	99 93000 10
5,56	44,45	5,537 à 5,918	99 91055 60	2	4,76	25,40	76,20	99 92000 20	2	99 93000 20
5,95	44,45	5,918 à 6,248	99 91059 50	2	4,76	25,40	76,20	99 92000 20	2	99 93000 20
6,35	50,80	6,324 à 6,705	99 91063 50	3	4,76	25,40	101,60	99 92000 30	3	99 93000 30
6,75	50,80	6,731 à 7,010	99 91067 50	3	4,76	25,40	101,60	99 92000 30	3	99 93000 30
7,14	50,80	7,112 à 7,340	99 91071 40	3	4,76	25,40	101,60	99 92000 30	3	99 93000 30
7,54	50,80	7,518 à 7,670	99 91075 40	3	4,76	25,40	101,60	99 92000 30	3	99 93000 30
7,94	50,80	7,924 à 8,305	99 91079 40	4	5,53	25,40	101,60	99 92000 40	4	99 93000 40
8,33	50,80	8,305 à 8,610	99 91083 30	4	5,53	25,40	101,60	99 92000 40	4	99 93000 40
8,73	50,80	8,712 à 8,915	99 91087 30	4	5,53	25,40	101,60	99 92000 40	4	99 93000 40
9,13	50,80	9,093 à 9,245	99 91091 30	4	5,53	25,40	101,60	99 92000 40	4	99 93000 40
9,53	63,50	9,499 à 9,855	99 91095 30	5	9,79	38,10	101,60	99 92000 50	5	99 93000 50
9,92	63,50	9,906 à 10,185	99 91099 20	5	9,79	38,10	127,00	99 92000 50	5	99 93000 50
10,32	63,50	10,287 à 10,515	99 91103 20	5	9,79	38,10	127,00	99 92000 50	5	99 93000 50
10,72	63,50	10,693 à 10,845	99 91107 20	5	9,79	38,10	127,00	99 92000 50	5	99 93000 50
11,11	63,50	11,074 à 11,430	99 91111 10	6	7,90	38,10	127,00	99 92000 60	6	99 93000 60
11,51	63,50	11,480 à 11,785	99 91115 10	6	7,90	38,10	127,00	99 92000 60	6	99 93000 60
11,91	63,50	11,861 à 12,090	99 91119 10	6	7,90	38,10	127,00	99 92000 60	6	99 93000 60
12,30	63,50	12,268 à 12,420	99 91123 00	6	7,90	38,10	127,00	99 92000 60	6	99 93000 60
12,70	82,55	12,674 à 13,081	99 91127 00	7	9,51	38,10	152,40	99 92000 70	7	99 93000 70
13,49	82,55	13,462 à 13,868	99 91134 90	7	9,51	38,10	152,40	99 92000 70	7	99 93000 70
14,29	82,55	14,249 à 14,579	99 91142 90	7	9,51	38,10	152,40	99 92000 70	7	99 93000 70
15,08	82,55	15,062 à 15,290	99 91150 80	7	9,51	38,10	152,40	99 92000 70	7	99 93000 70
15,88	82,55	15,849 à 16,256	99 91158 80	8	10,27	38,10	152,40	99 92000 80	8	99 93000 80
16,67	82,55	16,637 à 16,941	99 91166 70	8	10,27	38,10	152,40	99 92000 80	8	99 93000 80
17,46	82,55	17,424 à 17,627	99 91174 60	8	10,27	38,10	152,40	99 92000 80	8	99 93000 80
18,26	82,55	18,237 à 18,415	99 91182 60	8	10,27	38,10	152,40	99 92000 80	8	99 93000 80
19,05	88,90	19,024 à 19,380	99 91190 50	9	12,70	50,80	177,80	99 92000 90	9	99 93000 90
19,84	88,90	19,812 à 20,116	99 91198 40	9	12,70	50,80	177,80	99 92000 90	9	99 93000 90
20,64	88,90	20,599 à 20,853	99 91206 40	9	12,70	50,80	177,80	99 92000 90	9	99 93000 90
21,43	88,90	21,412 à 21,615	99 91214 30	9	12,70	50,80	177,80	99 92000 90	9	99 93000 90
22,23	88,90	22,199 à 22,580	99 91222 30	10	12,70	50,80	177,80	99 92001 00	10	99 93001 00
23,02	88,90	22,987 à 23,342	99 91230 20	10	12,70	50,80	177,80	99 92001 00	10	99 93001 00
23,81	88,90	23,774 à 24,079	99 91238 10	10	12,70	50,80	177,80	99 92001 00	10	99 93001 00
24,61	88,90	24,587 à 24,790	99 91246 10	10	12,70	50,80	177,80	99 92001 00	10	99 93001 00

EXTRACTORS

Characteristics	Ref.
For rods Ø 1,19 to 4,37 mm	99 94000 10
For rods Ø 4,76 to 15,48 mm	99 94000 20
For rods Ø 15,88 to 31,75 mm	99 94000 30

Any other dimension,
on demand.

Alumina abrasive films

High concentration abrasive films. Available in different grains from 0.3 μm to 40 μm , they generate excellent flatness and finishing results. The uniformity of the abrasive layer ensures exceptional regularity of the polishing process and prolonged durability of the disc. Easy to use, high stock removal and polishing quality enables you to significantly reduce your sample polishing time. They can be used with all material types.

Recommended lubricants: FLUIDE 712 water-based or FLUIDE 705 oil-based.

ALUMINA

100 pieces

Self-adhesive					
\emptyset mm	μm	Ref.	\emptyset mm	μm	Ref.
200	0,3	05A98A0200C	300	0,3	05A98A0300C
200	0,5	05A95A0200C	300	0,5	05A95A0300C
200	1	05A01A0200C	300	1	05A01A0300C
200	2	05A02A0200C	300	2	05A02A0300C
200	3	05A03A0200C	300	3	05A03A0300C
200	5	05A05A0200C	300	5	05A05A0300C
200	9	05A09A0200C	300	9	05A09A0300C
200	12	05A12A0200C	300	12	05A12A0300C
200	15	05A15A0200C	300	15	05A15A0300C
200	30	05A30A0200C	300	30	05A30A0300C
200	40	05A40A0200C	300	40	05A40A0300C
250	0,3	05A98A0250C	400	0,3	05A98A0400C
250	0,5	05A95A0250C	400	0,5	05A95A0400C
250	1	05A01A0250C	400	1	05A01A0400C
250	2	05A02A0250C	400	2	05A02A0400C
250	3	05A03A0250C	400	3	05A03A0400C
250	5	05A05A0250C	400	5	05A05A0400C
250	9	05A09A0250C	400	9	05A09A0400C
250	12	05A12A0250C	400	12	05A12A0400C
250	15	05A15A0250C	400	15	05A15A0400C
250	30	05A30A0250C	400	30	05A30A0400C
250	40	05A40A0250C	400	40	05A40A0400C



Alumina



ABRASIVE FILMS IN ROLLS

Films of all types available in rolls with choice of mandrel diameter, width from 1.2 to 100 mm, max length 200 meters.

Diamond abrasive films

High concentration abrasive films. Available in different grains from 0.5 μm to 45 μm , they generate excellent flatness and finishing results. The uniformity of the abrasive layer ensures great regularity of the polishing process and prolonged durability of the disc. Easy to use, the strong stock removal and polishing quality enables you to significantly reduce your sample polishing time. They can be used with all material types.

Recommended lubricants: FLUIDE 712 water-based or FLUIDE 705 oil-based.



Diamond

DIAMOND HC

5 pieces

Ø mm	Color	Self-adhesive		Non adhesive
		μm	Ref.	Ref.
200	Orange	45	05D45A02005	05D45N02005
200	Green	30	05D30A02005	05D30N02005
200	Brown	15	05D15A02005	05D15N02005
200	Light Blue	9	05D09A02005	05D09N02005
200	Yellow	6	05D06A02005	05D06N02005
200	Pink	3	05D03A02005	05D03N02005
200	Grey	1	05D01A02005	05D01N02005
200	Grey	0,5	05D95A02005	05D95N02005
250	Orange	45	05D45A02505	05D45N02505
250	Green	30	05D30A02505	05D30N02505
250	Brown	15	05D15A02505	05D15N02505
250	Light Blue	9	05D09A02505	05D09N02505
250	Yellow	6	05D06A02505	05D06N02505
250	Pink	3	05D03A02505	05D03N02505
250	Grey	1	05D01A02505	05D01N02505
250	Grey	0,5	05D95A02505	05D95N02505
300	Orange	45	05D45A03005	05D45N03005
300	Green	30	05D30A03005	05D30N03005
300	Brown	15	05D15A03005	05D15N03005
300	Light Blue	9	05D09A03005	05D09N03005
300	Yellow	6	05D06A03005	05D06N03005
300	Pink	3	05D03A03005	05D03N03005
300	Grey	1	05D01A03005	05D01N03005
300	Grey	0,5	05D95A03005	05D95N03005
400	Orange	45	05D45A04005	05D45N04005
400	Green	30	05D30A04005	05D30N04005
400	Brown	15	05D15A04005	05D15N04005
400	Light Blue	9	05D09A04005	05D09N04005
400	Yellow	6	05D06A04005	05D06N04005
400	Pink	3	05D03A04005	05D03N04005
400	Grey	1	05D01A04005	05D01N04005
400	Grey	0,5	05D95A04005	05D95N04005

POLISHING SUPPORTS

DIALAM diamond discs

The DIALAM supports are diamond composite supports with a high cutting capacity. Usable on single and double-side machines, they are recommended for pre-polishing processes requiring a high level of stock removal on all types of materials.

The DIALAM discs are particularly efficient for the stock removal on very hard materials as sapphires and ceramics.

Type	Characteristics	Ø (mm)	Qty.	Ref.
------	-----------------	--------	------	------

PLATE (coating stuck on a stainless steel)

DIALAM Blue (plate)	High roughness Thickness 3,5 mm	15"/381	1	09 DL140 30
DIALAM Green (plate)	Medium roughness Thickness 3,5 mm	15"/381	1	09 DL150 30

MAGNETIC DISCS (associated with FMS® fixing system)

DIALAM Blue (magnetic)	High roughness Thickness 3,5 mm	15"/381	1	09 DL141 30
DIALAM Green (magnetic)	Medium roughness Thickness 3,5 mm	15"/381	1	09 DL151 30



BOOSTER Lubricant

The Booster Lubricant has been specially developed to optimise the DIALAM's yield. It is distributed (drop by drop) during pre-polishing cycles and allows regenerating the DIALAM disc guaranteeing a regularity of the stock removal cycle after cycle.

Type	Packaging	Qty.	Ref.
Booster Fluid	5 litres	1	07 BP030 40



ABRABLOC Dressing ring

ABRABLOC dressing rings are intended for the dressing the DIALAM disc. They replace advantageously standard abrasive stones usually applied. The Abrablocs correct the plate geometry and brighten the cutting effect of DIALAM discs.

Type	Characteristics	Ø (mm)	Qty.	Ref.
------	-----------------	--------	------	------

ABRABLOC

ABRABLOC Brown	For DIALAM Blue	178 ext./ 158 int.	1	08 00200 60
ABRABLOC Ivory	For DIALAM Green	178 ext./ 158 int.	1	08 00201 60

ABRABLOC REFILLS (to stick on lapped aluminium support)

ABRABLOC Refill Brown	For DIALAM Blue	178 ext./ 158 int.	2	08 01200 50
ABRABLOC Refill Ivory	For DIALAM Green	178 ext./ 158 int.	2	08 01201 50

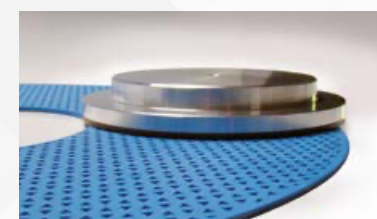

TOUCLAM®

TOUCLAM® polishing cloths

LAM PLAN proposes a new generation of TOUCLAM® polishing cloths. High technological products realised from exclusive materials, these cloths are intended to satisfy high precision demand concerning surfaces and geometry. The TOUCLAM® range is dedicated to aspect polishing and for all other kinds of accurate high quality polishing. Oriented towards industrial applications and research, these cloths integrate new materials and treatments in their manufacturing to facilitate their use and guarantee high quality results. Self-adhesive, their implementation is fast and easy. Available in all diameters.

Composition of TOUCLAM® polishing cloths

A polishing cloth is a complex gathering of various coats of materials, each one having their specific function:

- The active and visible part (1) of a cloth is the primary criteria. It gathers 4 classes, all with different characteristics.
- A coating (2) which defines the cloth's impermeability
- An adhesive film (3) having varying thickness and power of adhesion
- A support (4) defining the rigidity or the softness of the cloth.

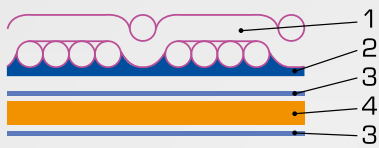

TOUCLAM® polishing cloths gathers 4 major classes:

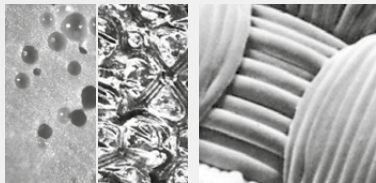

Polyurethanes and Foams

Woven

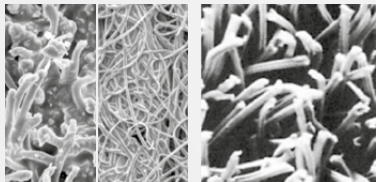

Non-woven and compressed

Flocked

For each application, the polishing cloth needs to be associated with the correct abrasive. LAM PLAN proposes 3 families of product: the diamond abrasives NEOLAP®, the composite abrasives ECOA® and the standard abrasive of the AQUA LAM® range.

The combination of these elements will allow to answer the 3 criteria composing the user's specification: stock removal (SR), flatness, finishing or roughness.

GUIDANCE

Summary table

TOUCLAM® polishing cloth	Characteristics			
	SR*	Flatness	Finishing	Super finishing
1PU1	X	X		
1PU2	X	X		
1PU3	X	X		
1PU4	X	X	X	
1PC1		X	X	
1PC2		X	X	
1NT2	X			
2NT1	X		X	
2PC1		X	X	X
2PC2		X	X	X
2TT2	X	X		
2TS1		X	X	
2TS2			X	
2FL1			X	
2FL2			X	
2MS1			X	
3FP1				X
3SE2		X	X	X
3SA2		X	X	X
3SA4		X	X	X
3FV1				X
3FV2				X
4FV3				X
4MP2				X

*Stock removal

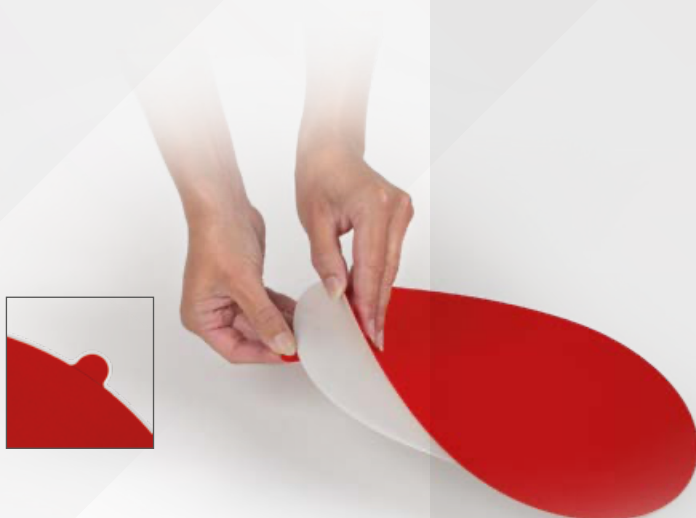

In order to facilitate the removal of the protection film, the self-adhesive TOUCLAM® cloths are equipped with a tab.

POLISHING SUPPORTS

1PU1

Box of 5 pieces

Characteristics	Ø in mm	Ref.
Polyurethane loaded with cerium oxide - Extra hard. From rough polishing to polishing of all materials. Inherent flatness and long life service. Commonly used with ECOA® abrasive slurries.	381	1PU10A03815
	400	1PU10A04005
	480	1PU10A04805
	610	1PU10A06105
	700	1PU10A07005



1PU2

Characteristics	Ø in mm	Ref.
Polyurethane loaded with zirconium oxide - Hard. From rough polishing to polishing of all materials. Inherent flatness and long life service. Commonly used with ECOA® abrasive slurries.	381	1PU20A03815
	400	1PU20A04005
	480	1PU20A04805

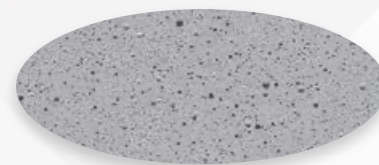

1PU3

Characteristics	Ø in mm	Ref.
Polyurethane not loaded - Hard. From rough polishing to polishing of all materials. Inherent flatness and long life service. Commonly used with ECOA® abrasive slurries. Available with grooves.	381	1PU30A03815
	400	1PU30A04005
	480	1PU30A04805
	610	1PU30A06105
	700	1PU30A07005



1PU4

Characteristics	Ø in mm	Ref.
Polyurethane loaded with cerium oxide - Medium-hard. From rough polishing to polishing of all materials. Inherent flatness and long life service. Commonly used with ECOA® abrasive slurries. Available with grooves.	381	1PU40A03815
	400	1PU40A04005
	480	1PU40A04805
	610	1PU40A06105
	700	1PU40A07005

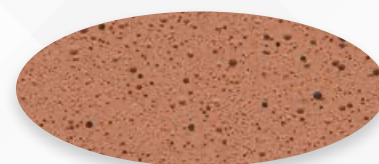

1PC1

Characteristics	Ø in mm	Ref.
Polyurethane compressed impregnated fibres. Extra hard. Excellent flatness, high durability. Can be used with all types of abrasives.	381	1PC10A03815
	400	1PC10A04005
	480	1PC10A04805
	610	1PC10A06105
	700	1PC10A07005
	914	1PC10A09145
	1000	1PC10A10005



1PC2

Characteristics	Ø in mm	Ref.
Polyurethane compressed impregnated fibres. Very hard. Excellent flatness, high durability. Can be used with all types of abrasives.	381	1PC20A03815
	400	1PC20A04005
	480	1PC20A04805
	610	1PC20A06105
	700	1PC20A07005
	914	1PC20A09145
	1000	1PC20A10005



**1NT2**

Box of 5 pieces

Characteristics	Ø in mm	Ref.
Non woven polyester - Fine. From rough polishing to the polishing of non ferrous materials. Commonly used with ECOA® and NEOLAP® abrasive slurries.	381	1NT20A03815
	400	1NT20A04005
	480	1NT20A04805
	610	1NT20A06105
	700	1NT20A07005
	914	1NT20A09145
	1000	1NT20A10005

**2NT1**

NEW

Characteristics	Ø in mm	Ref.
Non-woven polyester/polypropylene composite. High durability. Multi-purpose disc, can be used for rough or finish polishing. Commonly used with BioDIAMANT® NEOLAP® and ECOA abrasive slurries.	381	2NT10A03815
	400	2NT10A04005
	480	2NT10A04805
	610	2NT10A06105
	700	2NT10A07005
	914	2NT10A09145
	1000	2NT10A10005

**2PC1**

Characteristics	Ø in mm	Ref.
Polyurethane compressed impregnated polyester fibres - Hard. Excellent flatness and high durability. Can be used with diamond slurries or colloidal silicas. Available in various patterns.	381	2PC10A03815
	400	2PC10A04005
	480	2PC10A04805
	610	2PC10A06105
	700	2PC10A07005

**2PC2**

Characteristics	Ø in mm	Ref.
Polyurethane compressed impregnated with polyester fibres - Medium-dur. Excellent flatness and high durability. Commonly used with diamond slurries or colloidal silicon. Available in various patterns.	381	2PC20A03815
	400	2PC20A04005
	480	2PC20A04805
	610	2PC20A06105
	700	2PC20A07005

**2TT2**

Characteristics	Ø in mm	Ref.
Taffeta woven synthetic fibres. High stock removal and inherent flatness on all materials. High durability. Commonly used with NEOLAP® diamond slurries.	381	2TT20A03815
	400	2TT20A04005
	480	2TT20A04805
	610	2TT20A06105
	700	2TT20A07005

**2TS1**

Characteristics	Ø in mm	Ref.
Satin woven natural fibres. Excellent finishing of all materials. Good inherent flatness. Commonly used with NEOLAP® diamond slurries.	381	2TS10A03815
	400	2TS10A04005
	480	2TS10A04805
	610	2TS10A06105
	700	2TS10A07005
	914	2TS10A09145
1000	2TS10A10005	

POLISHING SUPPORTS

2TS2

Box of 5 pieces

Characteristics	Ø in mm	Ref.
Satin woven natural fibres on flexible support . Excellent finishing of all materials. Good durability. Commonly used with NEOLAP® diamond slurries.	381	2TS20A03815
	400	2TS20A04005
	480	2TS20A04805
	610	2TS20A06105
	700	2TS20A07005
	914	2TS20A09145
	1000	2TS20A10005

**2FL1**

Characteristics	Ø in mm	Ref.
Compressed wool felt. Finishing of plastics and glasses. High durability. Commonly used with AQUA LAM® cerium oxide.	381	2FL10A03815
	400	2FL10A04005
	480	2FL10A04805
	610	2FL10A06105
	700	2FL10A07005
	914	2FL10A09145
	1000	2FL10A10005

**2FL2**

Characteristics	Ø in mm	Ref.
Wool felt, extra flexible. Finishing of plastics and glasses. High durability. Commonly used with AQUA LAM® cerium oxide.	381	2FL20A03815
	400	2FL20A04005
	480	2FL20A04805
	610	2FL20A06105
	700	2FL20A07005
	914	2FL20A09145
	1000	2FL20A10005

**2MS1**

Characteristics	Ø in mm	Ref.
Foam. Finishing, on soft and medium-hard materials. Moulds to the shape of the part to be polished. Commonly used with ECOA® abrasive slurries.	381	2MS10A03815
	400	2MS10A04005
	480	2MS10A04805
	610	2MS10A06105
	700	2MS10A07005
	914	2MS10A09145
	1000	2MS10A10005

**3FP1**

Characteristics	Ø in mm	Ref.
Flocked polyester fibres. Finishing of organic and mineral glasses. Very resistant. Commonly used with AQUA LAM® oxides.	381	3FP10A03815
	400	3FP10A04005
	480	3FP10A04805
	610	3FP10A06105
	700	3FP10A07005
	914	3FP10A09145
	1000	3FP10A10005

**3SE2**

Characteristics	Ø in mm	Ref.
High-resistance synthetic silk fibres. Superfinishing of medium hard and soft materials. Excellent inherent flatness. Commonly used with NEOLAP® diamond slurries.	381	3SE20A03815
	400	3SE20A04005
	480	3SE20A04805
	610	3SE20A06105
	700	3SE20A07005
	914	3SE20A09145
	1000	3SE20A10005



**3SA2**

Box of 5 pieces

Characteristics	Ø in mm	Ref.
Synthetic silk fibres. Superfinishing of all types of materials. Excellent inherent flatness. Commonly used with NEOLAP® diamond slurries.	381	3SA20A03815
	400	3SA20A04005
	480	3SA20A04805
	610	3SA20A06105
	700	3SA20A07005
	914	3SA20A09145
	1000	3SA20A10005

**3SA4**

Characteristics	Ø in mm	Ref.
Composite synthetic fibres. Super finishing of soft materials . Good inherent flatness. Commonly used with NEOLAP® diamond slurries.	381	3SA40A03815
	400	3SA40A04005
	480	3SA40A04805
	610	3SA40A06105
	700	3SA40A07005
	914	3SA40A09145
	1000	3SA40A10005

**3FV1**

Characteristics	Ø in mm	Ref.
Semi-hard flocked short viscose fibres. Super finishing of hard materials. Commonly used with NEOLAP® diamond slurries.	381	3FV10A03815
	400	3FV10A04005
	480	3FV10A04805
	610	3FV10A06105
	700	3FV10A07005
	914	3FV10A09145
	1000	3FV10A10005

**3FV2**

Characteristics	Ø in mm	Ref.
Flocked short viscose fibres. Super finishing of all materials. Resistant to aggressive abrasive . Commonly used with NEOLAP® diamond slurries and AQUA LAM® oxides.	381	3FV20A03815
	400	3FV20A04005
	480	3FV20A04805
	610	3FV20A06105
	700	3FV20A07005
	914	3FV20A09145
	1000	3FV20A10005

**4FV3**

Characteristics	Ø in mm	Ref.
Soft flocked long viscose fibres. Super finishing of all materials, even very soft. Used with NEOLAP® diamond slurries and AQUA LAM® oxides.	381	4FV30A03815
	400	4FV30A04005
	480	4FV30A04805
	610	4FV30A06105
	700	4FV30A07005
	914	4FV30A09145
	1000	4FV30A10005

**4MP2**

Characteristics	Ø in mm	Ref.
Microporous polyurethane foam. Extreme super finishing of all materials (chemical polishing). High durability. Commonly used with colloidal silica AQUA LAM® oxides, and ECOA® abrasive slurries.	381	4MP20A03815
	400	4MP20A04005
	480	4MP20A04805
	610	4MP20A06105
	700	4MP20A07005
	914	4MP20A09145
	1000	4MP20A10005

Structured cloths

The polishing cloths **TOUCLAM® 1PU3 and 1PU4** are available with grooves on their surface in order to improve their performances. Dimensions: 10 x 10 mm and 30 x 30 mm, depth of the grooves: 1 mm.

The polishing cloths **TOUCLAM® 2PC1 and 2PC2** are available with various structures: embossed and quartered (dimensions of the grooves 4,3 x 4,3 mm and 18,4 x 18,4 mm). The action of the abrasive slurry is optimised on the entire surface of the parts.

The principal benefits are:

- Higher stock removal
- Excellent flatness control
- Limitation of the suction effect
- Modulation of the stock removal and surface condition.

Available structures for 1PU3 and 1PU4 with grooved matrix.



1PU4 grooved 10 x 10 mm



1PU4 grooved 30 x 30 mm

Available structure for 2PC1 and 2PC2 with grooved, and embossed matrix.

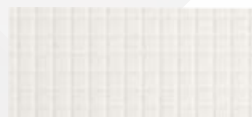

Grooved 4,3 x 4,3 mm



Grooved 18,4 x 18,4 mm



Embossed

Tailor-made cutting

LAM PLAN masters the production of its polishing cloths. In order to facilitate the use and the application of polishing cloths on your supports, we are capable of providing our discs, already cut to your needs. The geometry of the polishing cloth or pad will correspond perfectly to your fixation support. The cutting quality will be perfect which will guarantee a high durability of your polishing cloth.

We can provide all geometric shapes as the petals illustrated just below. For double-side machines, we make the bore and the holes for the distribution of the abrasive on the superior plate.



CONSUMABLES



DIAMOND SLURRIES

Bio DIAMANT® NEOLAP® abrasive slurries

All the experience of LAM PLAN in a diamond abrasive with incomparable performances. In direct line with our famous Bio DIAMANT® range, the NEOLAP® diamond abrasive slurries go even further in terms of efficiency and user comfort. The NEOLAP® diamond slurry is a top-of-the-range product featuring exceptional performances.

VOC-free products - Respect of users and environment

The products of our Bio DIAMANT® range are biodegradable by more than 70%. Non-toxic and harmless, they are neutral; the user's working conditions are thus respected. Anticipation of new regulations in terms of Volatile Organic Compounds (VOCs). Consolidation of your ISO 14001 and ISO 26000 approach.

Biodegradable packaging - Reduction of your activity's environmental impact

For the first time in the polishing industry, a diamond slurry is packed in a plastic bottle of vegetal origin which is 100% compostable according to standard 13432 (for 400 ml packagings).

High yield - Reduced consumption

After many years of development, LAM PLAN formulated a new range of diamond slurries whose performances are clearly better than those of the old generation of Bio DIAMANT® products.

The comparative tests conducted by LAM PLAN prove it. The results in terms of stock removal are systematically better, which places NEOLAP® at the front of the diamond abrasive market in terms of polishing efficiency and speed.

The wettability of these diamond slurries is specially designed and optimised for NEW LAM® M'M' plates. The ease with which the diamond slurry is spread out over the plate's surface allows obtaining rapidly an excellent abrasive film, which favours an immediate lapping.



NEOLAP®

DIAMOND ABRASIVE LIQUIDS

DIAMOND SLURRIES

Flatness

Contains specific additives to facilitate the mixing of the diamond slurry with the NEOFLUID lubricating fluid and improves the dissipation of heat from the plate during lapping.

Improved roughness

This new generation of diamond abrasive allows obtaining better roughness results while preserving a strong stock removal.

Easy cleaning

With water for NEOLAP® series 300 and 400.

Quality, procurement guarantee and total traceability

Conformity to the REACH regulation

LAM PLAN set up all the arrangements needed for its application in order to guarantee the quality and availability of all its products over the long term. All the substances contained in our preparations comply with the REACH regulation's specifications. To facilitate your administrative formalities, all the Safety Data Sheets (SDSs) of our products conform to the legislation in force can be downloaded from www.lamplan.fr/fds.

Availability in monocrystalline and polycrystalline forms

Series 100 emulsion - monocrystalline.

Series 300 water base - monocrystalline.

Series 400 water base - polycrystalline.

Bio DIAMANT® NEOLAP® slurries, key points

Use	Top-of-the-range diamond abrasive specific for lapping polishing applications	
Positioning	Ready-to-use, decantation-free, to be sprayed or dosed drop by drop. It is indicated for all your lapping work on NEW LAM® M'M' plates and polishing work on our range of polishing cloths	
Range	Monocrystalline, polycrystalline - grains from 1/4 to 45 µm	
Bases	Water and emulsion	
Packagings	400 ml - 2 L	
Lubricants	water base	712 or NEOFLUID
	emulsion base	712 or NEOFLUID



Monocrystalline diamond

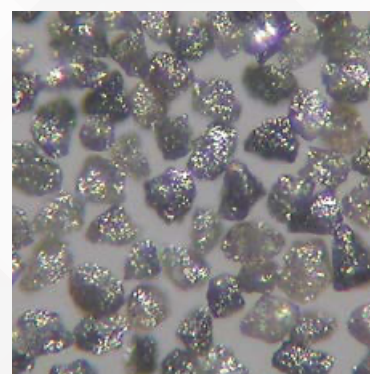

Polycrystalline diamond

Reference reading:

106 Grain in µm

Bases

- 1 = emulsion - monocrystalline
- 3 = water - monocrystalline
- 4 = water - polycrystalline

GUIDANCE

NEOLAP®



Diamond slurry
Single face
lapping polishing
VOC free, biodegradable
Aqueous detergent

Diamond slurries Bio DIAMANT® NEOLAP®

SERIES 100 - MONOCRYSTALLINE EMULSION

Type	µm	400 ml packaging		2 litres packaging	
		Ref.	Ref.	Ref.	Ref.
197	0,25	02 NO197 60		02 NO197 70	
195	0,75	02 NO195 60		02 NO195 70	
101	1	02 NO101 60		02 NO101 70	
102	2	02 NO102 60		02 NO102 70	
103	3	02 NO103 60		02 NO103 70	
106	6	02 NO106 60		02 NO106 70	
109	9	02 NO109 60		02 NO109 70	
112	12	02 NO112 60		02 NO112 70	
115	15	02 NO115 60		02 NO115 70	
125	25	02 NO125 60		02 NO125 70	
145	45	02 NO145 60		02 NO145 70	

SERIES 300 - MONOCRYSTALLINE WATER BASE

Type	µm	400 ml packaging		2 litres packaging	
		Ref.	Ref.	Ref.	Ref.
397	0,25	02 NO397 60		02 NO397 70	
395	0,75	02 NO395 60		02 NO395 70	
301	1	02 NO301 60		02 NO301 70	
302	2	02 NO302 60		02 NO302 70	
303	3	02 NO303 60		02 NO303 70	
306	6	02 NO306 60		02 NO306 70	
309	9	02 NO309 60		02 NO309 70	
312	12	02 NO312 60		02 NO312 70	
315	15	02 NO315 60		02 NO315 70	
325	25	02 NO325 60		02 NO325 70	
345	45	02 NO345 60		02 NO345 70	

SERIES 400 - POLYCRYSTALLINE WATER BASE

Type	µm	400 ml packaging		2 litres packaging	
		Ref.	Ref.	Ref.	Ref.
497	0,25	02 NO497 60		02 NO497 70	
495	0,75	02 NO495 60		02 NO495 70	
401	1	02 NO401 60		02 NO401 70	
402	2	02 NO402 60		02 NO402 70	
403	3	02 NO403 60		02 NO403 70	
406	6	02 NO406 60		02 NO406 70	
409	9	02 NO409 60		02 NO409 70	
412	12	02 NO412 60		02 NO412 70	
415	15	02 NO415 60		02 NO415 70	
425	25	02 NO425 60		02 NO425 70	



DIAMOND SLURRIES

Diamond slurries 241 series

High performance, oil-based polycrystalline diamond abrasives.

The high lapping performances of these products allow obtaining excellent results in terms of brightness and roughness on very hard materials, such as ceramics or silicon carbide.

Containing additives which limit the diamond's settling out, the suspension of these abrasives is thus facilitated and very rapid, which guarantees a perfect homogenisation of the product before usage.

These ready-to-use- products can be used with the lubricating fluid MM990-140 or MM950-140.

The formulation of these diamond slurries is particularly adapted to materials sensitive to water.

Parts are cleaned with Stanol or detergent 742.



Diamond slurry
Single face
lapping polishing
0% of water
No decantation

SERIES 241 - MONOCRYSTALLINE

Type	µm	500 ml packaging		5 litres packaging	
		Ref.	Ref.	Ref.	Ref.
99 241	0,1	02 99241 00		02 99241 40	
97 241	0,25	02 97241 00		02 97241 40	
01 241	1	02 01241 00		02 01241 40	
02 241	2	02 02241 00		02 02241 40	
03 241	3	02 03241 00		02 03241 40	
06 241	6	02 06241 00		02 06241 40	
09 241	9	02 09241 00		02 09241 40	
14 241	14	02 14241 00		02 14241 40	
25 241	25	02 25241 00		02 25241 40	

SERIES 241P - POLYCRYSTALLINE

Type	µm	500 ml packaging		5 litres packaging	
		Ref.	Ref.	Ref.	Ref.
99 241P	0,1	02 99241P 00		02 99241P 40	
97 241P	0,25	02 97241P 00		02 97241P 40	
01 241P	1	02 01241P 00		02 01241P 40	
02 241P	2	02 02241P 00		02 02241P 40	
03 241P	3	02 03241P 00		02 03241P 40	
06 241P	6	02 06241P 00		02 06241P 40	
09 241P	9	02 09241P 00		02 09241P 40	
14 241P	14	02 14241P 00		02 14241P 40	
25 241P	25	02 25241P 00		02 25241P 40	

ECOa®



Multi abrasives
Double side polishing
Custom-made formulas
Packaging 5 L

Conform to the REACH regulation

LAM PLAN established solutions to guarantee quality and availability of all its products on the long run. All the substances present in our preparations respond to the specifications of the REACH regulations. In order to facilitate your administrative process, all the safety data sheet (SDS) of our products are in compliance with the current legislation.

ECOa® abrasive slurries

New ranges of liquid slurries for double plate machines. The ECOa® range is carrying all LAM PLAN's knowledge in terms of classic and diamond slurries applied for polishing and super-finishing on double plate machines. It is the guarantee of an efficient response to various materials.

Ready-to-use high quality industrial products

The manufacturing and the packaging are adapted to the constraints and consumption encountered in industrial production polishing.

Control your VOC emission

For many years, the LAM PLAN R&D department has been committed to develop new products respecting the user's health but also the environment without compromising the efficiency. Composed with a specific new generation binder, this slurry is VOC free (Volatile Organic Compounds).

Improved technical performances

The abrasive film, specially elaborated for double side lapping polishing assures a good distribution of the slurry on the polishing supports. The new generation formulations reduce heating during the polishing process and keep the abrasive film wet.

Improved roughness

The varied ECOa® range guarantees the best results with a high stock removal on all materials.

Easy cleaning

Specially conceived to limit and distribute the polishing residues, the ECOa® liquids can be washed easily with water or with aqueous detergents.

Respect the users and the environment

The products of the ECOa® range are biodegradable by more than 70%. Nontoxic and harmless, the users' working condition are thus respected. Also anticipating the new regulations concerning greenhouse gas emission. Consolidation of your ISO 14001 and ISO 26000 approach.

Supply guarantee and total traceability

Prices on demand - Available range (non exhaustive list)

GUIDANCE

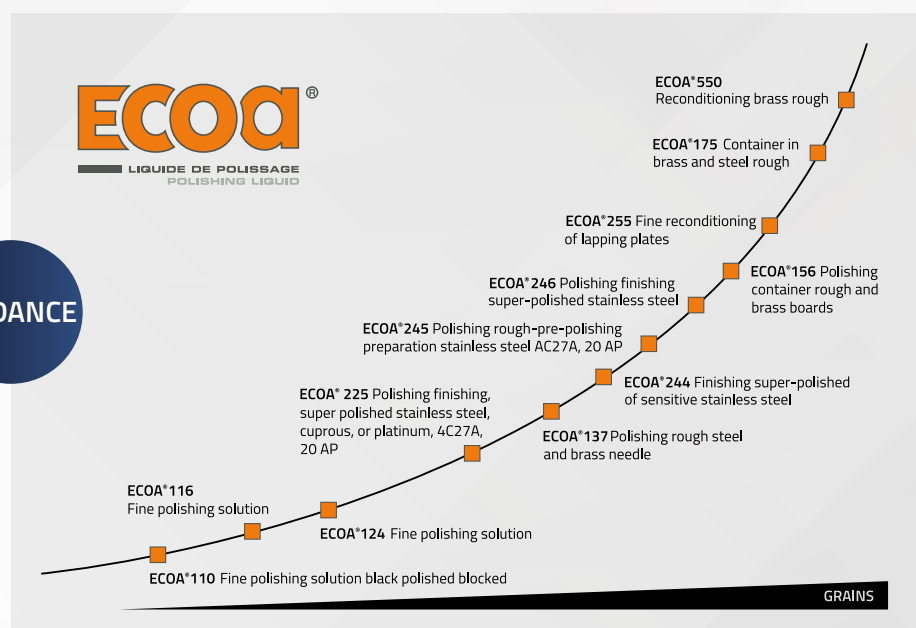

DIAMOND SLURRIES

Stick Bio DIAMANT® M.M.140 A

Diamond pastes dosing stick for the finishing of watch parts.

Characteristics

The Bio DIAMANT® M.M.140 A stick is constituted of a solid chemical binder, soluble in water and oil. The Bio DIAMANT® M.M.140 A stick can be used with the M.M.712 fluid (water base) or with the M.M.705 fluid (oil base).

Applications

Particularly recommended for the watch parts. Easy to use, its yield and its abrasive quality allows obtaining exceptional results well known in this branch of industry. Its pairing with TOUCHLAM® polishing cloths authorises the final polishing of various materials and principally the ones used in the watchmaking field (brass, silver, stainless steel, stavax, coating, etc.). It is often used in restoring terminated parts, to remove micro-scratches, it can also be integrated in a complete production polishing process.

Use and presentation

This stick is intended for manual use. The accurate dosing of the paste distribution is insured by a graduated drum. Each division represents 0.2 gram.

This system allows loading any new polishing cloth with a perfectly repetitive material without direct contact with the product.

BIO DIAMANT®



Diamond paste
Manual polishing
Proven results
High efficiency
High abrasive capacity

Characteristics	Packaging	Type	µm	Ref.
Monocrystalline diamond High concentration	10 g	M.M.140 A	<1	01 MM149 00

These are the necessary quantities to load a new polishing cloth:

Nature of cloth	Ø 150 mm	Ø 200 mm	Ø 250 mm	Ø 300 mm	Ø 400 mm
Woven	0,2 g	0,2 g	0,4 g	0,4 g	0,6 g
Flocked	0,3 g	0,4 g	0,5 g	0,6 g	0,7 g

Please adjust each operation according to the surface of the samples.

GUIDANCE

BIO DIAMANT®



Manual use on
lapping and polishing plates
and blocks

High efficiency
High abrasive capacity

Diamond abrasive
Manual lapping
For composite rods

Bio DIAMANT® Sticks

The sticks allow controlling the dosage in manual usage on lapping plates.

The diamond paste is distributed according to an accurate dosage, thanks to a drum, graduated every 0.2 g. The loading of the paste on the plate is insured to be repetitive and without finger contact.

SERIES M.M.130-140

Extra concentrated in monocrystalline diamond, these high performance sticks allow a high and fast stock removal on all types of materials. Their high concentration facilitates also the rapid acquisition of flat and shiny surfaces. The cleaning is done with water or detergent 742.

The M.M.130 series sticks are used for ROUGH operations.

The M.M.140 series sticks are used for FINISHING operations.

Characteristics	Type	µm	Ref.
10 g Finishing	MM 140 A	0,75	01 MM149 00
	MM 145	1	01 MM145 00
	MM 144	2	01 MM144 00
	MM 143	3	01 MM143 00
	MM 142	6	01 MM142 00
	MM 141	9	01 MM141 00
10 g Rough	MM 133	12	01 MM133 00
	MM 132	14	01 MM132 00
	MM 131	25	01 MM131 00

8% discount from 3 products of the same reference

SERIE 122

High concentration monocrystalline diamond sticks, for all rough and finishing operations. The identification of grains of these sticks are colour coded in order to limit the risks of committing mistakes during the use. The cleaning can be done with water, alcohol or detergent 742.

Characteristics	Type	µm	Ref.
10 g Finishing on polishing support	025 122	1/4	01 97122 00
	1 122	1	01 01122 00
	3 122	3	01 03122 00
	6 122	6	01 06122 00
	9 122	9	01 09122 00
	15 122	15	01 15122 00

8% discount from 3 products of the same reference

DIAMOND SLURRIES

Bio DIAMANT® pastes

Oil soluble pastes, with high diamond concentration, insuring an important productivity on hard and extra hard materials.

Use with lubricant type M.M.705. These pastes are available in 1 to 90 µm grains. The cleaning of your parts can be done with water or alcohol.

SERIE 210

Characteristics	Type	µm	Ref.
10 g High yield abrasive Hard and extra-hard materials	1 213	1	01 01213 00
	3 213	3	01 03213 00
	6 213	6	01 06213 00
	8 213	8	01 08213 00
	14 213	14	01 14213 00
	25 213	25	01 25213 00
	40 213	40	01 40213 00
	60 213	60	01 60213 00
	90 213	90	01 90213 00

5% discount from 3 products of the same reference



Diamond abrasive

Lapping bore

0% of water

**Lubrication
anti-heating**

Diadoseurs Bio DIAMANT®**BIO DIAMANT® GELS SERIES 400**

Characteristics	Type	µm	Ref.
30 g Diadoseur precision Finishing on rods	01 400	1	010140030
	03 400	3	010340030
	06 400	6	010640030
	08 400	8	010840030
	14 400	14	011440030
	25 400	25	012540030



**Concentrated
diamond abrasive**

**Ultra precise
distribution**

**Repeatability
of the distribution**

GUIDANCE

These are the necessary quantities to load a new polishing cloth:

Nature of cloth	Ø 150 mm	Ø 200 mm	Ø 250 mm	Ø 300 mm	Ø 400 mm
Woven	0,2 g	0,2 g	0,4 g	0,4 g	0,6 g
Flocked	0,3 g	0,4 g	0,5 g	0,6 g	0,7 g

Please adjust each operation according to the surface of the samples.

**Lubricant**

**Dedicated to materials
sensitive to corrosion**

**Lubricant**

**Lapping
in high production**

Use with a dosing distributor

Lubricant

0 % of water

Dedicated for manual use

Lubricant

0 % of water

Use with a dosing distributor

Fluids

NEOFLUID

Lubricating fluid recommended for Bio DIAMANT® NEOLAP® slurries. Formulation without volatile organic compounds (VOCs) and without dangerous substances, this biodegradable fluid is adapted for the lapping and polishing of most materials. It allows controlling perfectly the heating of the lapping plates during production cycles, thereby guaranteeing excellent flatness. Its association with the Bio DIAMANT® NEOLAP® slurries guarantees a stable, uniform abrasive film during the various work processes. Its active principles protect materials sensitive to corrosion.

Packaging	Ref.
1 litre	07 NEF10 30
5 litres	07 NEF10 40

M.M.712

Aqueous lubricating fluid recommended with the Bio DIAMANT® series 122 and M.M.130-140, and liquid series M.M.330-340. It is compatible with the new Bio DIAMANT® NEOLAP® slurries series 300 and 400. Ready to use, its specific formula prevents the support from heating and facilitates the cleaning of parts with water or by adding the detergent 742.

Packaging	Ref.
1 litre	07 MM712 30
5 litres	07 MM712 40
Pulmatic 350 cc	07 MM712 50

M.M.705

Lubricating fluid to be used with the diamond compounds series 210. Ready-to-use, it ensures an excellent dispersion of the compound and optimises its lapping power. Cleans easily with the detergent 742 or Stanol.

Packaging	Ref.
1 litre	07 MM705 30
Pulmatic 350 cc	07 MM705 50

M.M.990-140

This lubricant fluid is recommended for usages with the diamond slurries series 241P. Ready-to-use, its low viscosity creates a very fine abrasive film during the work process, which ensures a high lapping efficiency. It is compatible with the new Bio DIAMANT® NEOLAP® series 100 and M.M. 130-140. Use the detergent 742, Stanol or apply solvents to clean the parts.

Packaging	Ref.
1 litre	07 MM711 30
5 litres	07 MM711 40

M.M.950-140

Oil-based lubricating fluid. Due to its low evaporation rate, it is recommended for large lapping or polishing support. This fluid is not subjected to the regulation on the transport of dangerous materials (ADR, IMDG, IATA).

Packaging	Ref.
1 litre	07 MM950 30
5 litres	07 MM950 40

MANUAL DISTRIBUTOR

Characteristics	Packaging	Réf.
Bottle to be filled	Pulmatic 350 cc - 2 units	08 00802 00

COMPOSITE ABRASIVES

CLASSICAL composite abrasive

A high-performance product which has proven its adaptability to all usage, especially for large tanks and intensive usage. According to the concentration intended, 1 litre of abrasive solution allows obtaining between 5 and 10 litres of abrasive.

Advantages

- Increasing working speed.
- Easy resuspension of the mixture.
- Soft abrasive film, efficient and balanced.
- Very low smell.
- Low running costs.
- Easy cleaning. Detergent 711-103.
- Ingenious packaging: packs 2 x 2 litres stackable and 4 x 2 litres (reduced handling). Concentrated abrasive slurry, easy-to-use and easy cleaning.

1 pack of 2 x 2 litres = 20 to 30 litres of solution. These products allow working with abrasive concentration adjustable to usage. Requiring a brewing while using it. Easy resuspension. Compatible with the additive 716.



Conventional abrasives
Lapping on cast iron plates

ALUMINIUM OXYDE (Al₂O₃)

FEPA	µm	2 x 2 litres pack		4 x 2 litres pack	
		Ref.		Ref.	
180	74	A074 S12L2		A074 S12L4	
220	62	A062 S12L2		A062 S12L4	
240	45	A045 S12L2		A045 S12L4	
280	37	A037 S12L2		A037 S12L4	
320	29	A029 S12L2		A029 S12L4	
360	23	A023 S12L2		A023 S12L4	
400	17	A017 S12L2		A017 S12L4	
500	13	A013 S12L2		A013 S12L4	
600	9	A009 S12L2		A009 S12L4	
800	7	A007 S12L2		A007 S12L4	
1000	5	A005 S12L2		A005 S12L4	
1200	3	A003 S12L2		A003 S12L4	
1500	1	A001 S12L2		A001 S12L4	

SILICON CARBIDE (SiC)

FEPA	µm	2 x 2 litres pack		4 x 2 litres pack	
		Ref.		Ref.	
180	74	E074 S12L2		E074 S12L4	
220	62	E062 S12L2		E062 S12L4	
240	45	E045 S12L2		E045 S12L4	
280	37	E037 S12L2		E037 S12L4	
320	29	E029 S12L2		E029 S12L4	
360	23	E023 S12L2		E023 S12L4	
400	17	E017 S12L2		E017 S12L4	
500	13	E013 S12L2		E013 S12L4	
600	9	E009 S12L2		E009 S12L4	
800	7	E007 S12L2		E007 S12L4	
1000	5	E005 S12L2		E005 S12L4	
1200	3	E003 S12L2		E003 S12L4	

The CLASSICAL composite abrasive is also available in Boron carbide (B₄C) and cerium oxide (CeO₂). Other grains on demand.



Conventional abrasive
Lapping on cast
iron plate
Biodegradable

BIOLAM® composite abrasive

A new generation of biodegradable abrasive slurries developed by our Research and Development services. Very useful for the lapping machine equipped with a medium size tank.

Advantages

- Easy to use and to put in work.
- Low decantation of the abrasive, regularity of results.
- Consistent and ready abrasive film.
- No dangerous substances.
- Low running costs.
- Very low smell.
- Simple and easy cleaning (ex: water or water + ordinary detergent).
- Compact packaging: 2 and 20 litres jerrycans other packaging on demand.

BIOLAM® PLUS TO DILUTE AND BIOLAM S READY-TO-USE

Plus: Smooth abrasive slurry, no smell, biodegradable, easy to clean. Limited decantation, no additive needed. dilute 1 to 5 times in water.

S: Biodegradable and no smell liquid slurry, non-toxic. Easy to clean. Simple usage: to put directly in the abrasive tank of the machine, limited decantation. Depending of the use can be used pure or can be diluted up to 2 times in water.

BIOLAM® Oxyde d'aluminium (Al_2O_3)

BIOLAM® PLUS to dilute

BIOLAM® S ready-to-use

FEPA	µm	Container of 2 litres		Container of 20 litres	
		Ref.	Ref.	Ref.	Ref.
100	125	A125 V92L1	A125 V9020		
120	105	A105 V92L1	A105 V9020		
150	88	A088 V92L1	A088 V9020	A088 V62L1	A088 V6020
180	74	A074 V92L1	A074 V9020	A074 V62L1	A074 V6020
220	62	A062 V92L1	A062 V9020	A062 V62L1	A062 V6020
240	45	A045 V92L1	A045 V9020	A045 V62L1	A045 V6020
280	37	A037 V92L1	A037 V9020	A037 V62L1	A037 V6020
320	29	A029 V92L1	A029 V9020	A029 V62L1	A029 V6020
360	23	A023 V92L1	A023 V9020	A023 V62L1	A023 V6020
400	17	A017 V92L1	A017 V9020	A017 V62L1	A017 V6020
500	13	A013 V92L1	A013 V9020	A013 V62L1	A013 V6020
600	9	A009 V92L1	A009 V9020	A009 V62L1	A009 V6020
800	7	A007 V92L1	A007 V9020	A007 V62L1	A007 V6020
1000	5	A005 V92L1	A005 V9020	A005 V62L1	A005 V6020
1200	3	A003 V92L1	A003 V9020	A003 V62L1	A003 V6020
1400	2	A002 V92L1	A002 V9020		
1500	1	A001 V92L1	A001 V9020	A001 V62L1	A001 V6020
1800	0,7	CP70 V92L1		CP70 V62L1	CP70 V6020
2000	0,4	CP40 V92L1		CP40 V62L1	CP40 V6020
2200	0,2	CP20 V92L1		CP20 V62L1	CP20 V6020
4500	0,05	CP05 V92L1		CP05 V62L1	CP05 V6020

COMPOSITE ABRASIVES

BIOLAM® Silicon carbide (SiC)**BIOLAM®PLUS to dilute**

FEPA	µm	Container of 2 litres		Container of 20 litres		BIOLAM®S ready-to-use	
		Ref.	Ref.	Ref.	Ref.	Ref.	Ref.
80	177	E177 V92L1	E177 V9020	E177 V62L1	E177 V6020		
100	125	E125 V92L1	E125 V9020	E125 V62L1	E125 V6020		
120	105	E105 V92L1	E105 V9020	E105 V62L1	E105 V6020		
150	88			E088 V62L1	E088 V6020		
180	74	E074 V92L1	E074 V9020	E074 V62L1	E074 V6020		
220	62	E062 V92L1	E062 V9020	E062 V62L1	E062 V6020		
240	45	E045 V92L1	E045 V9020	E045 V62L1	E045 V6020		
280	37	E037 V92L1	E037 V9020	E037 V62L1	E037 V6020		
320	29	E029 V92L1	E029 V9020	E029 V62L1	E029 V6020		
360	23	E023 V92L1	E023 V9020	E023 V62L1	E023 V6020		
400	17	E017 V92L1	E017 V9020	E017 V62L1	E017 V6020		
500	13	E013 V92L1	E013 V9020	E013 V62L1	E013 V6020		
600	9	E009 V92L1	E009 V9020	E009 V62L1	E009 V6020		
800	7	E007 V92L1	E007 V9020	E007 V62L1	E007 V6020		
1000	5	E005 V92L1	E005 V9020	E005 V62L1	E005 V6020		
1200	3	E003 V92L1	E003 V9020	E003 V62L1	E003 V6020		
1360	1,5			F1P5 V62L1	F1P5 V6020		
1500	1			F001 V62L1	F001 V6020		
1800	0,7			FP70 V62L1	FP70 V6020		

BIOLAM® Cerium oxyde (CeO₂) liquid

Finishing Liquid for the finishing on glass, sapphire and plastic. Dilute 2 to 5 times in water. 2 litres tin.

BIOLAM®PLUS to dilute

FEPA	Container of 2 litres	
	µm	Ref.
1200	3	I003 V92L1
1300	2	I002 V92L1
1400	1	I001 V92L1

The composite abrasives BIOLAM® are also available in boron carbide (B₄C) and cerium oxide (CeO₂).

Other grains on demand.

**Dilution of AQUALAM® CLASSIC and BIOLAM®PLUS solutions**

- 1 part concentrated abrasive product
- 2 parts ADDITIVE 716
- 4 parts tap water

ADDITIVE 716 optimises the abrasive film and protects the parts and the cast iron plate from corrosion.

GUIDANCE



Super-finishing
Polishing on cloth discs
Simplified cleaning

AQUA LAM® colloidal silica

The colloidal silicas are stabilised suspensions with fine non-agglomerated spherical particles. This aqueous solution contains a high concentration of nanoscale silica.

During usage, colloidal silicas are generally diluted in water to proportions between 10 and 50%. We advise a 20% dilution in water for an optimum use.

These products are always used for super-finishing.

S.W. 30

Chemical-mechanical abrasive for compatible material
 Super-finishing standard liquid to use pure or diluted up to 50%
 Silica concentration: 30%
 Size of particles: 30 nm
 pH = 10

Packaging	Ref.
5 litres tin	Z000 A25L1
10 litres tin	Z000 A2010

S.W. 36

Silica concentration : 50%
 Size of particles : 50 nm
 pH = 9

Packaging	Ref.
5 litres tin	Z000 C55L1
10 litres tin	Z000 C5610

NOVAL S FINISHING

Super-finishing liquid. Obtaining ultra-low roughness
 Contains an additive "anti-crystallisation" which facilitate the cleaning of the parts and the machines. Silica concentration : 30%
 Size of particles: 30 nm
 pH = 10

Packaging	Ref.
5 litres tin	Z000 F75L1
10 litres tin	Z000 F7010
20 litres tin	Z000 F7020

NOVAL CONCENTRATED

Formulated to be added to pure colloidal silica
 Additive that cancels crystallisation and decantation of the pure colloidal silica pure
 Increases the stock removal, powers the roughness
 Silica concentration: 35%
 Size of particles: 30 nm
 pH = 9

Packaging	Ref.
10 litres tin	Z000 F8010
20 litres tin	Z000 F8020

COMPOSITE ABRASIVES

Abrasive compounds BIOLAP®

Concentrated fluid abrasive pastes. Oil base, auto-lubricants, intended for the lapping of parts between them and/or cylindrical lapping.

Biodegradables, no smell, no dangerous substances.

Advantages

- VOC free
- No water spots
- Alumina base, silicon carbide or boron carbide
- Grains from 0,05 to 125 microns
- Biodegradable products
- Low viscosity
- Packaging: in 50 and 250 cm³ pots



BIOLAP® L SERIES

Conventional abrasives

Complex parts Lapping polishing

Fluid texture



BIOLAP® Cr L SERIES

Conventional abrasives and chromium oxide

Lapping polishing

Operations under high constraints

Resistant to friction and heating

BIOLAP® Aluminium oxide (Al₂O₃)

BIOLAP® L SERIES

FEPA	µm	Pot of 50 cm ³		Pot of 250 cm ³	
		Ref.	Ref.	Ref.	Ref.
100	125	A125 O3P05	A125 O3P25	A125 O5P05	A125 O5P25
120	105	A105 O3P05	A105 O3P25	A105 O5P05	A105 O5P25
150	88	A088 O3P05	A088 O3P25	A088 O5P05	A088 O5P25
180	74	A074 O3P05	A074 O3P25	A074 O5P05	A074 O5P25
220	62	A062 O3P05	A062 O3P25	A062 O5P05	A062 O5P25
240	45	A045 O3P05	A045 O3P25	A045 O5P05	A045 O5P25
280	37	A037 O3P05	A037 O3P25	A037 O5P05	A037 O5P25
320	29	A029 O3P05	A029 O3P25	A029 O5P05	A029 O5P25
360	23	A023 O3P05	A023 O3P25	A023 O5P05	A023 O5P25
400	17	A017 O3P05	A017 O3P25	A017 O5P05	A017 O5P25
500	13	A013 O3P05	A013 O3P25	A013 O5P05	A013 O5P25
600	9	A009 O3P05	A009 O3P25	A009 O5P05	A009 O5P25
800	7	A007 O3P05	A007 O3P25	A007 O5P05	A007 O5P25
1000	5	A005 O3P05	A005 O3P25	A005 O5P05	A005 O5P25
1200	3	A003 O3P05	A003 O3P25	A003 O5P05	A003 O5P25
1500	1	A001 O3P05	A001 O3P25	A001 O5P05	A001 O5P25
1800	0,7	CP70 O3P05	CP70 O3P25	CP70 O5P05	CP70 O5P25
2000	0,4	CP40 O3P05	CP40 O3P25	CP40 O5P05	CP40 O5P25
2200	0,2	CP20 O3P05	CP20 O3P25	CP20 O5P05	CP20 O5P25
4500	0,05	CP05 O3P05	CP05 O3P25	CP05 O5P05	CP05 O5P25

BIOLAP® Cr L SERIES

FEPA	µm	Pot of 50 cm ³		Pot of 250 cm ³	
		Ref.	Ref.	Ref.	Ref.
100	125	A125 O3P05	A125 O3P25	A125 O5P05	A125 O5P25
120	105	A105 O3P05	A105 O3P25	A105 O5P05	A105 O5P25
150	88	A088 O3P05	A088 O3P25	A088 O5P05	A088 O5P25
180	74	A074 O3P05	A074 O3P25	A074 O5P05	A074 O5P25
220	62	A062 O3P05	A062 O3P25	A062 O5P05	A062 O5P25
240	45	A045 O3P05	A045 O3P25	A045 O5P05	A045 O5P25
280	37	A037 O3P05	A037 O3P25	A037 O5P05	A037 O5P25
320	29	A029 O3P05	A029 O3P25	A029 O5P05	A029 O5P25
360	23	A023 O3P05	A023 O3P25	A023 O5P05	A023 O5P25
400	17	A017 O3P05	A017 O3P25	A017 O5P05	A017 O5P25
500	13	A013 O3P05	A013 O3P25	A013 O5P05	A013 O5P25
600	9	A009 O3P05	A009 O3P25	A009 O5P05	A009 O5P25
800	7	A007 O3P05	A007 O3P25	A007 O5P05	A007 O5P25
1000	5	A005 O3P05	A005 O3P25	A005 O5P05	A005 O5P25
1200	3	A003 O3P05	A003 O3P25	A003 O5P05	A003 O5P25
1500	1	A001 O3P05	A001 O3P25	A001 O5P05	A001 O5P25
1800	0,7	CP70 O3P05	CP70 O3P25	CP70 O5P05	CP70 O5P25
2000	0,4	CP40 O3P05	CP40 O3P25	CP40 O5P05	CP40 O5P25
2200	0,2	CP20 O3P05	CP20 O3P25	CP20 O5P05	CP20 O5P25
4500	0,05	CP05 O3P05	CP05 O3P25	CP05 O5P05	CP05 O5P25

BIOLAP® Silicon carbide (SiC)

BIOLAP® L SERIES

FEPA	µm	Pot of 50 cm ³		Pot of 250 cm ³	
		Ref.	Ref.	Ref.	Ref.
80	177	E177 O3P05	E177 O3P25	E177 O5P05	E177 O5P25
100	125	E125 O3P05	E125 O3P25	E125 O5P05	E125 O5P25
120	105	E105 O3P05	E105 O3P25	E105 O5P05	E105 O5P25
150	88	E088 O3P05	E088 O3P25	E088 O5P05	E088 O5P25
180	74	E074 O3P05	E074 O3P25	E074 O5P05	E074 O5P25
220	62	E062 O3P05	E062 O3P25	E062 O5P05	E062 O5P25
240	45	E045 O3P05	E045 O3P25	E045 O5P05	E045 O5P25
280	37	E037 O3P05	E037 O3P25	E037 O5P05	E037 O5P25
320	29	E029 O3P05	E029 O3P25	E029 O5P05	E029 O5P25
360	23	E023 O3P05	E023 O3P25	E023 O5P05	E023 O5P25
400	17	E017 O3P05	E017 O3P25	E017 O5P05	E017 O5P25
500	13	E013 O3P05	E013 O3P25	E013 O5P05	E013 O5P25
600	9	E009 O3P05	E009 O3P25	E009 O5P05	E009 O5P25
800	7	E007 O3P05	E007 O3P25	E007 O5P05	E007 O5P25
1000	5	E005 O3P05	E005 O3P25	E005 O5P05	E005 O5P25
1200	3	E003 O3P05	E003 O3P25	E003 O5P05	E003 O5P25

BIOLAP® Cr L SERIES

For personalised formulation please contact us (free estimate).

GUIDANCE

Dilution of AQUALAM® CLASSIC and BIOLAM®PLUS solutions

- 1 part concentrated abrasive product
- 2 parts ADDITIVE 716
- 4 parts tap water

ADDITIVE 716 optimises the abrasive film and protects the parts and the cast iron plate from corrosion.

COMPOSITE ABRASIVES

Abrasive compounds CLASSIC

High concentration abrasive compound. Optimises the texture of the abrasive film in order to obtain a rapid, maximal and extended abrasion. Non greasy, miscible to water and to the additive 716.

ALUMINIUM OXIDE (Al₂O₃)

FEPA	µm	Pot of 1 kg		Bucket of 10 kg	
		Ref.		Ref.	
100	125	A125 R101K		A125 R110K	
120	105	A105 R101K		A105 R110K	
150	88	A088 R101K		A088 R110K	
180	74	A074 R101K		A074 R110K	
220	62	A062 R101K		A062 R110K	
240	45	A045 R101K		A045 R110K	
280	37	A037 R101K		A037 R110K	
320	29	A029 R101K		A029 R110K	
360	23	A023 R101K		A023 R110K	
400	17	A017 R101K		A017 R110K	
500	13	A013 R101K		A013 R110K	
600	9	A009 R101K		A009 R110K	
800	7	A007 R101K		A007 R110K	
1000	5	A005 R101K		A005 R110K	
1200	3	A003 R101K		A003 R110K	



Abrasifs conventionnels
High purity

SILICON CARBIDE (SiC)

FEPA	µm	Pot of 1 kg		Bucket of 10 kg	
		Ref.		Ref.	
120 ébauche	105	E105 R101K		E105 R110K	
180 moyen	74	E074 R101K		E074 R110K	
240 fine	45	E045 R101K		E045 R110K	
320	29	E029 R101K		E029 R110K	
400	17	E017 R101K		E017 R110K	
500	13	E013 R101K		E013 R110K	
600	9	E009 R101K		E009 R110K	
1000	5	E005 R101K		E005 R110K	
1200	3	E003 R101K		E003 R110K	

For personalised formulations, please contact us (free estimate).



Standard abrasive
High purity

AQUA LAM® Al₂O₃ powder

ALUMINIUM OXIDE

Commonly called "polishing alumina", chemical symbol Al₂O₃. They are composed of various family: purified aluminas, melted aluminas, calcinated aluminas, submicron aluminas. Their choice is defined according to result criterias and economical expectancies. Grains included between 0,03 micron and 200 microns.

FEPA	µm	Bucket of 5 kg	
		Ref.	Ref.
100	125	A125 P105K	A125 P125K
120	105	A105 P105K	A105 P125K
150	88	A088 P105K	A088 P125K
180	74	A074 P105K	A074 P125K
220	62	A062 P105K	A062 P125K
240	45	A045 P105K	A045 P125K
280	37	A037 P105K	A037 P125K
320	29	A029 P105K	A029 P125K
360	23	A023 P105K	A023 P125K
400	17	A017 P105K	A017 P125K
500	13	A013 P105K	A013 P125K
600	9	A009 P105K	A009 P125K
800	7	A007 P105K	A007 P125K
1000	5	A005 P105K	A005 P125K
1200	3	A003 P105K	A003 P125K
1500	1	A001 P105K	A001 P125K



Standard abrasive
High purity

AQUA LAM® SiC powder

SILICON CARBIDE

The silicon carbide is a pure chemical corps, chemical symbol SiC. The grains are grey, green or black. The grain F1500 used for specific super-finishing is grey.

The silicon carbide AQUA LAM® endures a special treatment and a separation under a high magnetic intensity to insure a dusting and a maximal cleaning. AQUA LAM® proposes all the grains FEPA F useful in lapping, from F60 (250 microns) to F1200 (3 microns).

FEPA	µm	Bucket of 5 kg		Bucket of 25 kg	
		Ref.	Ref.	Ref.	Ref.
60	250	E250 P105K		E250 P125K	
80	177	E177 P105K		E177 P125K	
100	125	E125 P105K		E125 P125K	
120	105	E105 P105K		E105 P125K	
150	88	E088 P105K		E088 P125K	
180	74	E074 P105K		E074 P125K	
220	62	E062 P105K		E062 P125K	
240	45	E045 P105K		E045 P125K	
280	37	E037 P105K		E037 P125K	
320	29	E029 P105K		E029 P125K	
360	23	E023 P105K		E023 P125K	
400	17	E017 P105K		E017 P125K	
500	13	E013 P105K		E013 P125K	
600	9	E009 P105K		E009 P125K	
800	7	E007 P105K			
1000	5	E005 P105K			
1200	3	E003 P105K			

COMPOSITE ABRASIVES

AQUA LAM® CeO₂ powder**CERIUM OXIDE**

Chemical symbol CeO₂. Used in super finishing mostly for the polishing of glass (example BK7, 520 knoops) the cerium oxide reduces the roughness by a chemical and mechanical actions. Selected according to its maximum polishing action, the cerium oxide AQUA LAM® has grains from 3 to 0,5 microns (other grains dimensions on demand).

FEPA	µm	Pot of 1 kg		Pot of 500 g	
		Ref.		Ref.	
1200	3	I003 P101K		I003 P1P5K	
1300	2	I002 P101K		I002 P1P5K	
1400	1	I001 P101K		I001 P1P5K	
1500	0,7	JP70 P101K		JP70 P1P5K	
1600	0,5	JP50 P101K		JP50 P1P5K	

**Additive**

Additive for liquid preparations CLASSIQUES and BIOLAM®PLUS allowing an optimisation of the abrasive film (more resistant) without reducing the lapping power. Can be used in the preparation of the abrasive solution in addition to water.

Preserves the parts and the cast iron tray from corrosion.

ADDITIF 716

Packaging	Ref.
Can of 5 litres	Z000 F25L1
Can of 10 litres	Z000 F2010
Can of 20 litres	Z000 F2020
Keg of 200 litres	Z000 F2200



Lapping oil

Classic lapping oil to use with the abrasive powder.

OIL 708

Packaging	Ref.
Can of 5 litres	Z000 A35L1
Can of 10 litres	Z000 A3010
Can of 20 litres	Z000 A3020
Keg of 60 litres	Z000 A3060



Lubricant for cylindrical lapping

AQUASUN OIL

Packaging	Ref.
Can of 10 litres	Z000 A4010

GUIDANCE



Correspondences between different standards

MICRON µm	MESH	FEPA F Abratif libre	W (grain)	GRIT ASTM
3	1200	F1200	W14	1200
5	1000	F1000	W10	-
7	800	F800	W9	-
9	600	F600	W7/8	800
13	500	F500	W5/6	600
18	400	F400	W4	500
23	360	F360	W2	400
29	320	F320	W0	360
37	280	F280	W350	280
45	240	F240	W340	240
58	220	F220	W240	220

GENERAL TERMS AND CONDITIONS OF SALE

1. Application of General Terms & Conditions of Sale

All orders placed with Lam Plan imply acceptance by the client, without any reservation, of all the General Terms and Conditions of Sale as set forth here below.

Client orders shall be registered by Lam Plan only in accordance with these General Terms and Conditions of Sale, regardless of contrary provisions, if any, that may be contained in the purchase order or in the general terms and conditions of purchase of the client, unless they have been expressly accepted in writing by Lam Plan.

The waiver by Lam Plan of one or more provisions of these General Terms and Conditions of Sale does not imply the waiver of any other provisions thereof which shall remain effective and binding upon the client.

The present General Terms and Conditions of Sale may be amended at any time without prior notice by Lam Plan, with the amendments thereafter being applicable to all subsequent orders.

The Client acknowledges being fully aware that their agreement with respect to the contents of these General Terms and Conditions of Sale does not require their signing of this document.

2. Orders

The sale shall be deemed to have been completed only upon acceptance of the order from the client by Lam Plan.

The products shall be supplied and invoiced at the relevant price rates in effect at the time of placing of the order or, where applicable, in accordance with the specific commercial proposal addressed to the client and accepted by them.

Any eventual amendments to the order subsequently made by the client shall be taken into account, only within the limits of the possible options available and at the sole discretion of Lam Plan, and provided that they have been notified in writing to Lam Plan at least fifteen days prior to the date scheduled for delivery, accompanied with the issuance of a new specific purchase order duly signed by the client, including, where appropriate, a price adjustment.

3. Prices

The prices indicated in the Lam Plan catalogues are provided for illustrative purposes only and are not binding upon Lam Plan.

Appropriate invoices shall be issued in accordance with the price rates in force on the date of the order.

Unless otherwise specified in writing, all rates and prices are expressed in Euro and quoted net, ex works, exclusive of taxes and packaging.

As a consequence, the client shall bear all costs related to VAT at the applicable rate, transportation costs, fees and duties as well as any expenses associated with insurance.

Special pricing terms and conditions may be applicable depending upon the specifications requested by the client, particularly concerning the specific modalities, terms and timelines of delivery, timing and terms and conditions of payment.

In this event a special commercial offer shall be prepared and sent to the client by Lam Plan.

4. Payment

The quoted price shall be payable in full in one single payment within a period of thirty days from the date of issue of the invoice, end of the month.

In case of late payment, Lam Plan may suspend any pending orders without prejudice to the application of late payment penalty fees that will be due as of the day following the settlement date as indicated on the invoice, applicable on the full amount/s due, calculated at three times the interest rate in effect on the date of implementation of this provision and applied by the European Central Bank.

Moreover, and in accordance with Article L 441-6 of the Code de Commerce (French Commercial Code), in addition to late payment penalties, the client shall be required to pay a lump sum amount of 40 Euros for recovery costs, with Lam Plan however, reserving the right to seek additional compensation on upon presentation of supporting documentation, corresponding to the recovery costs incurred, in excess of the lump sum amount.

5. Retention of Ownership Title

Lam Plan retains the right to reserve ownership title of the goods delivered to the client until payment has been made in full, inclusive of principal, interest and ancillary costs.

However, the risks relating to the goods shall be transferred to the client immediately upon delivery and, for the entire period of time corresponding to the Retention of Ownership Title by Lam Plan.

Client shall agree, therefore, to take out appropriate insurance policies to provide adequate coverage against the risk of loss, theft or destruction of the goods prior to full payment being made.

Without prejudice to any subsequent action or claim for compensation for damages, Lam Plan may terminate the sale, with the aforementioned goods being subject to repossession in totality by Lam Plan without prior notice provided thereof, in the event of non payment of any invoices that become due.

The client shall refrain from pledging as collateral or assigning ownership of the said goods until such time as they have fully settled the payment corresponding to the price thereof.

In the event of the client becoming the subject of bankruptcy proceedings or getting involved in any other event making it impossible to pay for the goods delivered by Lam Plan and where the goods were to be sold in part or whole by the client to a subsequent purchaser, without the subsequent purchaser being discharged from the liability of paying the sale price, with respect to the client, the client shall agree to promptly provide Lam Plan with all information necessary for Lam Plan to make any eventual claim on the goods, against the corresponding claim related to the sale price still owed by the subsequent purchaser.

6. Delivery

Delivery dates and time lines are purely indicative, provided only for informative purposes and as such, are in no way guaranteed.

In this regard, Lam Plan's obligation is an obligation in terms of means and not an obligation in terms of result.

As a consequence, possible delays in delivery therefore may not be considered grounds for the cancellation of the order, refusal of the goods, the allocation of penalties or any claim for compensatory damages.

Lam Plan shall therefore not be held responsible for any delays in or suspension of delivery, errors, disruptions attributable to their service providers, contractors and / or subcontractors, or due to any unforeseeable fortuitous circumstances or force majeure events, as recognised by the French courts.

The Lam Plan warehouses shall constitute the place of delivery.

This rule shall not be subject to any derogation whatsoever on account of the management, in whole or in part, of the transportation of goods by Lam Plan.

In such a case, Lam Plan shall act in the capacity of a mere agent of the client, with the transportation risks being entirely borne by the client.

Unless otherwise stipulated in relevant provisions, the goods shall be transported at the sole risk and expense of the client, by carrier, and shall be delivered to the address indicated by them in the purchase order.

The client shall be responsible for checking and verifying the condition of the goods upon receipt.

In the event of goods that are missing or that have been damaged in transit, the client shall undertake to express all the necessary reservations on the delivery note or transportation waybill, upon receipt of the said goods.

In addition, these reservations must be confirmed to the carrier in accordance with Article L 133-3 of the French Commercial Code, in writing, within three days following the receipt of goods, by registered letter with acknowledgment of receipt.

It shall be up to the client to exercise their rights in respect of any eventual claims against the carrier or carriers.

6bis. Return

Returns of goods for other reasons than non-conformity may be made within 15 days from the date of receipt of the delivery, subject to prior written notification by the customer.

The shipping or return costs are at the customer's expense. The return of the product(s) must be made in its original packaging and in good condition. All damaged, spoiled, incomplete or soiled products will not be refunded. LAM PLAN reserves the right to decide whether or not to issue a refund after quality control.

7. Limited warranty

New materials and equipment sold by LAM PLAN are guaranteed against any manufacturing risk for a period of one year from the date of invoice of the delivered material.

The purchaser is obliged to check the condition of the materials and equipment immediately after receipt and must notify LAM PLAN within 10 days after receipt if any defects are discovered.

LAM PLAN then undertakes, at its own discretion, to remedy any malfunction during the warranty period, either by repairing the product, replacing the product or refunding the purchase price, provided that the materials and equipment have been used in normal conditions, with LAM PLAN brand products and with regular maintenance.

The warranty does not cover repairs due to:

- the use of materials supplied by the customer or of a design imposed by him;

- incidents due to fortuitous events or force majeure, normal wear and tear of the product, negligence of the customer, lack of supervision or maintenance, or non-conforming, inappropriate or improper use;

- storage or packaging conditions that do not comply with professional rules and practices or with the specificities of the product;

- defects in assembly or implementation by the customer, or the actions of a third party;

- modifications or repair work carried out by the customer or a third party without the prior written authorization of LAM PLAN.

Furthermore, LAM PLAN does not grant any warranty regarding:

- the actual performance of the Products, other than their ability to meet the specifications set by LAM PLAN;

- the electronic components of the Products or their associated accessories, including but not limited to printed circuit boards and integrated circuits.

The customer is obliged to give LAM PLAN the necessary time and means to carry out the necessary repairs and/or replacements, failing which LAM PLAN's warranty will no longer be due to the customer.

LAM PLAN's warranty is, therefore, strictly limited as indicated above.

By express agreement, all damages of any nature whatsoever resulting from damage inherent in the defects of the goods are excluded from the guarantee.

9. Copyright

Ownership of copyrights for all documents in all classes is retained by Seller. Buyer is granted a license to make, without further approval by Seller, a limited number of copies, in whole or in part, of a document, so long as the copied portion includes the applicable copyright and trademark statements found on the original document.

The reproduction for promotional purposes of all or part of texts, images and graphic elements is strictly prohibited without the express permission of LAM PLAN.

10. Applicable Law

All provisions of these General Terms and Conditions of Sale are exclusively subject to French law with respect to the interpretation and enforcement thereof.

11. Assignment of Jurisdiction

Any dispute arising from the interpretation and / or enforcement of these General Terms and Conditions of Sale shall be subject to a process of discussion and consultation with a view to achieving an amiable settlement.

Failing such a settlement being obtained within a period of two months from the date the dispute was notified and acknowledged, the dispute shall be brought before the Tribunal de Commerce de Paris (Commercial Court of Paris) who will have sole jurisdiction in the matter.

This clause shall be applicable, including in the event of summary proceedings, fixed date petition hearings and proceedings, incidental claims, plurality of defendants or third parties, and without the possibility of any hindrance thereto arising from the jurisdiction assignment clauses contained in the client's documents.



POLISHING TECHNOLOGY®

BY YOUR SIDE
EVERYWHERE IN THE WORLD



Algeria
Australia
Austria
Belgium
China
Czech Republic
France
Germany
Greece

Hungary
India
Indonesia
Israel
Italy
Japan
Korea
Malaysia
Norway

Poland
Portugal
Russia
Saudi Arabia
Singapore
Spain
Sweden
Switzerland
Taiwan

Thailand
The Netherlands
Turkey
United Arab Emirates
United Kingdom
United States

Distributed by



LAM PLAN SA
7 rue des Jardins - BP15
74240 GAILLARD - France
Tel. +33 (0)4 50 43 96 30

www.lamplan.com